



MACCHINA DA CAFFÈ AUTOMATICA AUTOMATIC COFFEE MAKERS

DE' LONGHI PRIMADONNA ----avant---- ESAM6700 EX: 2

(INT/CH/ATDE)

DATITECNICI/TECHNICALDATA/TECHNISCHEDATEN DONNEESTECNIQUES/DATOSTECNICOS

Voltaggio / Voltage / Spannung / Voltage / Voltaje V / Hz 220-240 50/60

Max. potenza assorbita / Max. input power W 1350

SEZIONECAFFÈ'/COFFEESECTIONS

Sonda termica / Temperature probe °C 97 (Caffè temp. media / Coffee normal temp)
°C 97 (Acqua calda / Hot water)

Fusibile termico TCO / Thermal fuse TCO °C 192

Resistenza riscaldamento / Heating element W 1200

Pompa / Pump TYPE / W ULKA EP 5 / 48

SEZIONE VAPORE / STEAM SECTION

Sonda termica / Temperature probe °C 145 (Vapore / Steam)

Fusibile termico TCO / Thermal fuse TCO / Thermische-Sicherung TCO
Fusible thermique TCO / Fusible térmico TCO °C 192

Resistenza riscaldamento / Heating element / Heizelement
Elément chauffant / Resistencia de calefacción W 1000

SCHEMA ELETTRICO / ELECTRICAL DIAGRAM

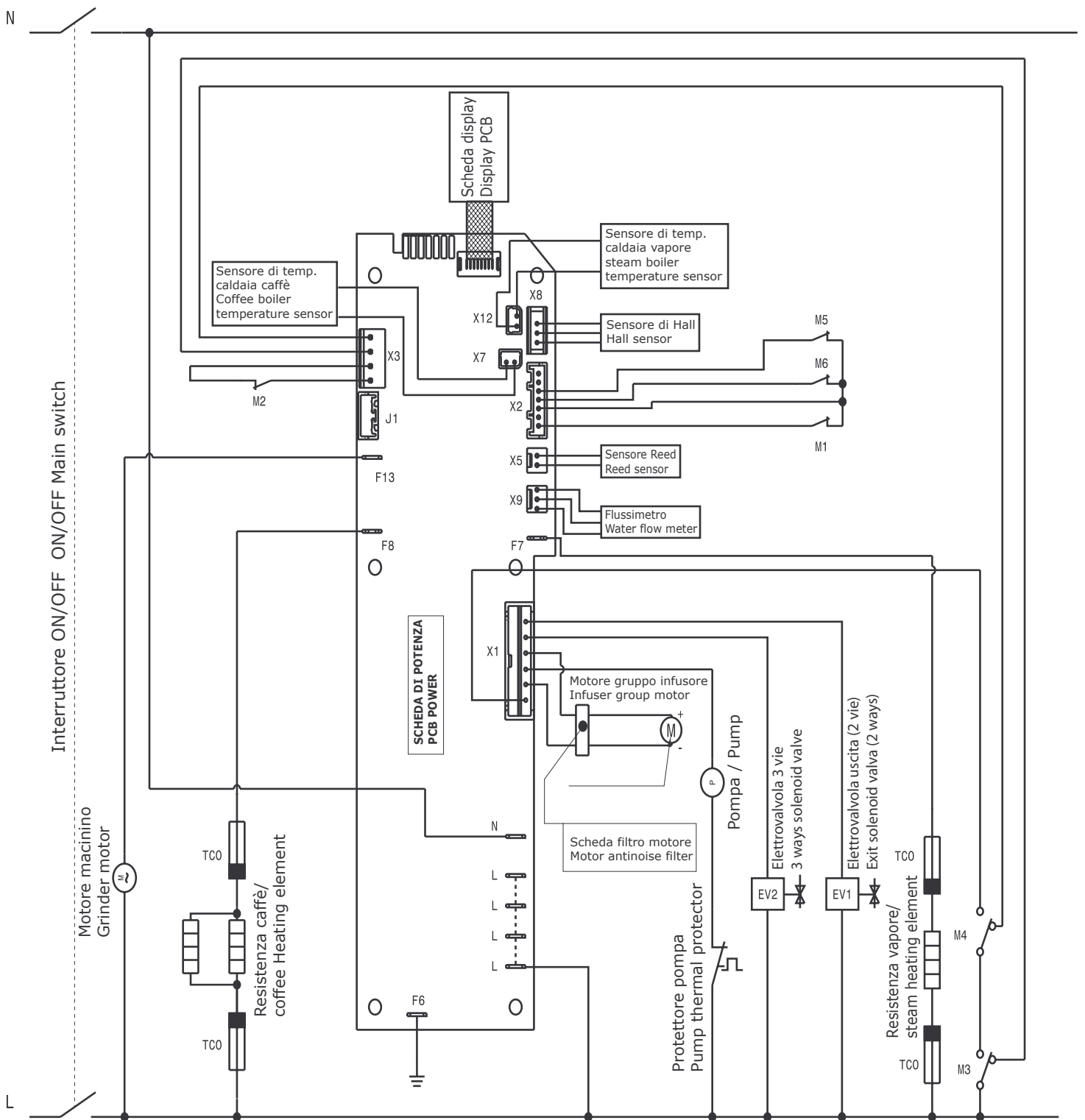



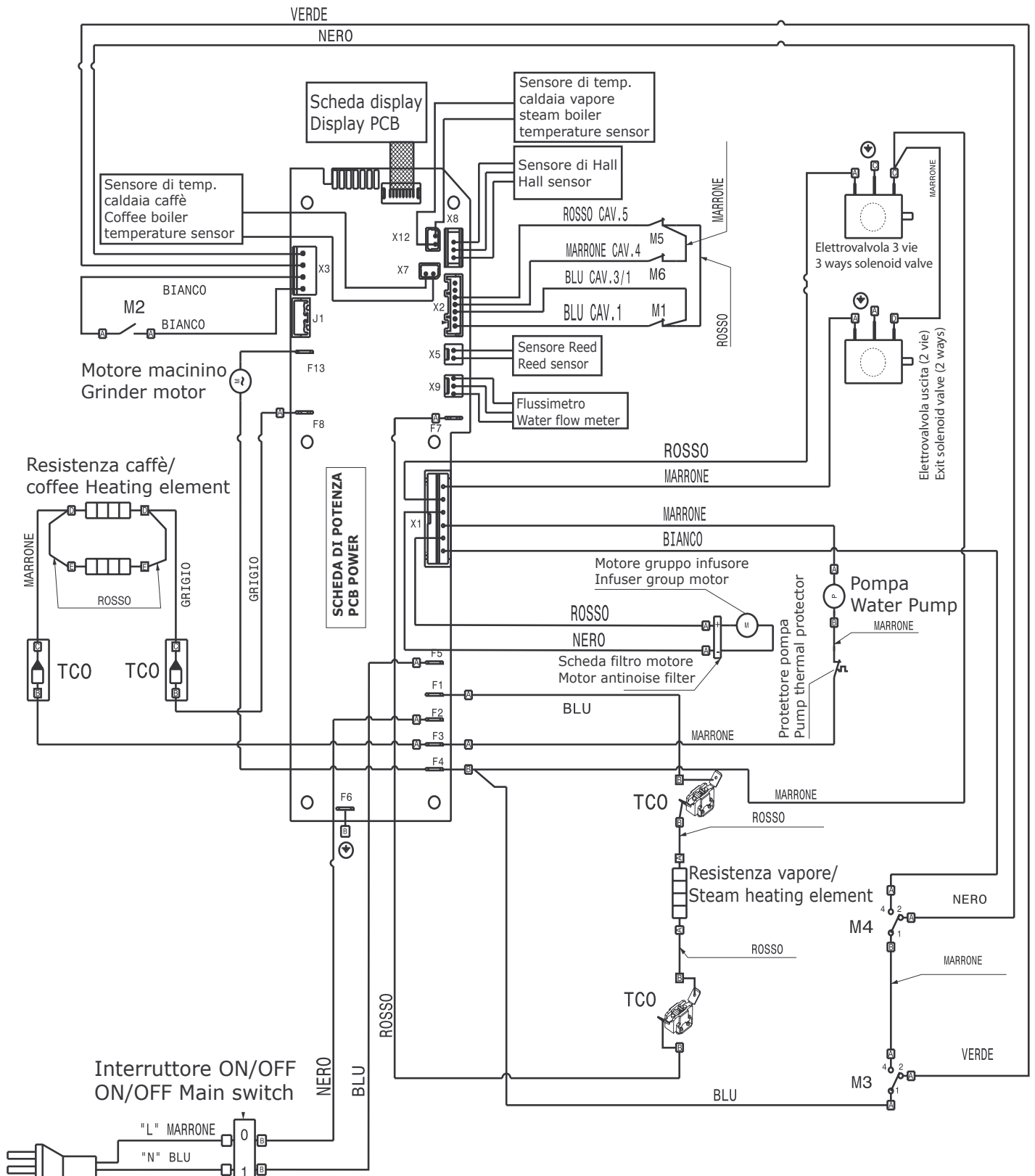







SCHEMA ELETTRICO / ELECTRICAL DIAGRAM



Legenda colori / Legend for colors
BIANCO / WHITE
BLU / BLUE
G / V (GIALLO / VERDE) / YELLOW / GREEN
GRIGIO / GREY
MARRONE / BROWN
NERO / BLACK
ROSSO / RED
VERDE / GREEN









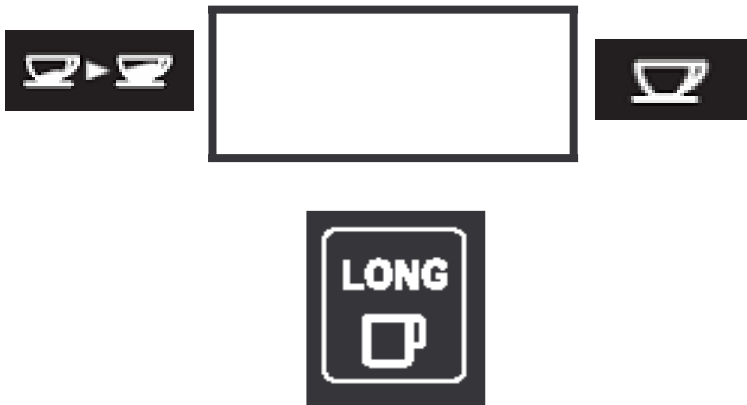

Legenda micro / Microswitches
M1 = Infusore alto / Infuser top position
M2 = Infusore basso / Infuser bottom position
M3 = Cassetto fondi / Coffee grounds container
M4 = Portina service / Service door
M5 = Presenza dispositivo IFD / IFD device in place
M6 = Presenza erogatore acqua calda / Hot water spout in place











TEST PROCEDURE	Pressing each icon below, we can manually check the devices:	
	icon	devised
<p>To enter the procedure: with the machine in stand-by (plugged in with the main switch on I, but machine OFF), open the Service door. Keep the 3 icons, as underneath, pressed till on the display is shown the message "SELECT TEST". Close the door and then press on the icon "CAPPUCCINO". The display will show the message: "LOAD TEST MODE"</p> 		Water pump
		Group moving motor UP till LIMIT switch UP
		Coffee boiler "Heater ON"
		Vaporizer ON
		EV2 ON
		EV1 ON
		EV1 ON + EV2 ON
		Grinder ON
		Group moving motor DOWN till LIMIT switch DOWN











To exit the procedure, switch off the machine from the main switch.



DISPLAY TEST PROCEDURE FOR ESAM6700 PrimaDonna - avant- EX:2

DISPLAY TEST PROCEDURE	Pressing each icon the display will show following message		
	icon	message	
<p>To enter the procedure: with the machine in stand-by (plugged in with the main switch on I, but machine OFF), open the Service door. Keep the 3 icons, as underneath, pressed till on the display is shown the message "SELECT TEST". Close the door and then press on the icon "CAFFELATTE". The display will show the message: "BUTTON"</p> 		BUTTON 2	
		BUTTON 3	
		BUTTON 1	
		BUTTON 10	
		BUTTON 8	
		BUTTON 9	
		BUTTON 5	
		BUTTON 4	
		BUTTON 0	
		BUTTON 6	
	<p>The machine will automatically exit the procedure after 1 minute This test resets the language and will restart from the pump priming</p>		

PROCEDURA DI TEST	Premendo le varie icone, si alimentano i seguenti dispositivi:	
	icona	dispositivo
<p>Per entrare nella procedura di test: macchina in stand-by collegata alla rete, interruttore principale (sul retro) su I (ON), ma macchina spenta, aprire la portina Service. Tenere premute le 3 icone (vedi disegno), finchè sul display compare il messaggio "SELECT TEST". Chiudere la portina e premere sull'icona "CAPPUCCINO". Sul display comparirà il messaggio: "LOAD TEST MODE"</p> 		Pompa acqua
		Motore movimentazione infusore, verso l'alto fino a chiudere micro finecorsa superiore: "limit switch up"
		Caldaia caffè: "HEATER ON"
		Caldaia vapore: "CUP VARMER ON"
		EV2 ON
		EV1 ON
		EV1 ON + EV2 ON
		Motore macinino: "GRINDER ON"
		Motore movimentazione infusore, verso il basso fino a chiudere micro finecorsa inferiore: "limit switch down"
	<p>Per uscire dalla procedura, spegnere la macchina o scollegarla dalla rete</p>	

PROCEDURA DI TEST DISPLAY	Premendo su ciascuna icona si visualizza il seguente messaggio:	
	icona	messaggio
<p>Per entrare nella procedura di test: macchina in stand-by collegata alla rete, interruttore principale (sul retro) su I (ON), ma macchina spenta, aprire la portina Service. Tenere premute le 3 icone (vedi disegno), finchè sul display compare il messaggio "SELECT TEST". Chiudere la portina e premere sull'icona "CAFFELATTE". Sul display comparirà il messaggio: "BUTTON"</p> 		BUTTON 2
		BUTTON 3
		BUTTON 1
		BUTTON 10
		BUTTON 8
		BUTTON 9
		BUTTON 5
		BUTTON 4
		BUTTON 0
		BUTTON 6

**La macchina uscirà automaticamente dalla procedura dopo 1 minuto
Il test implica il reset della lingua impostata e abilita al primo innesco**