

BUNN®

***ICBA, ICBB, ICBC,
ICB-DV, ICB Twin
Infusion Series®
with Smart Funnel®***
Supercedes Operating Manuals:
37077.0000; 38112.0001

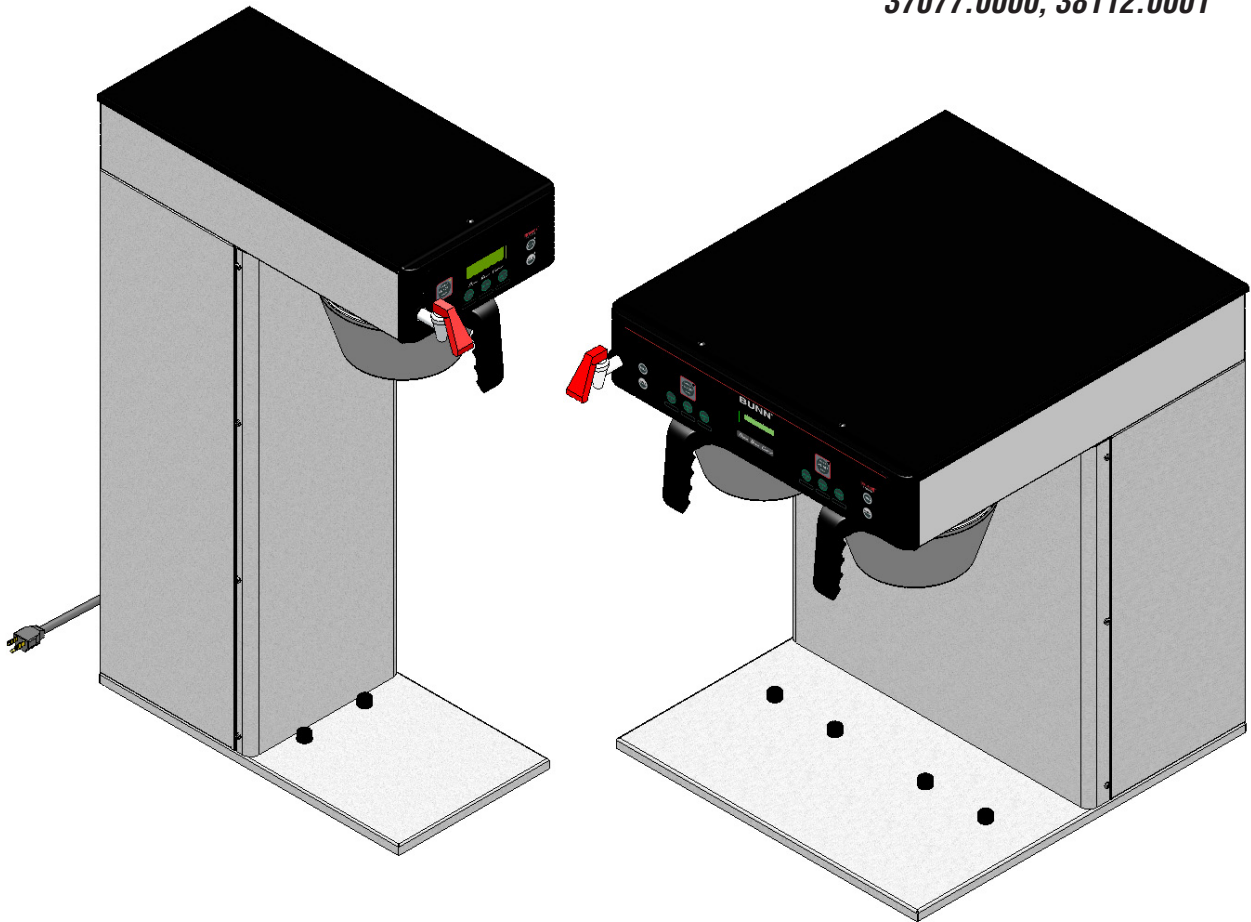

INSTALLATION & OPERATING GUIDE

BUNN-O-MATIC CORPORATION

POST OFFICE BOX 3227

SPRINGFIELD, ILLINOIS 62708-3227

PHONE: (217) 529-6601 FAX: (217) 529-6644

To ensure you have the latest revision of the Operating Manual, or to view the Illustrated Parts Catalog, Programming Manual, or Service Manual, please visit the Bunn-O-Matic website, at www.bunn.com. This is absolutely FREE, and the quickest way to obtain the latest catalog and manual updates. For Technical Service, contact Bunn-O-Matic Corporation at 1-800-286-6070.



BUNN-O-MATIC COMMERCIAL PRODUCT WARRANTY

Bunn-O-Matic Corp. ("BUNN") warrants equipment manufactured by it as follows:

- 1) Airpots, thermal carafes, decanters, GPR servers, iced tea/coffee dispensers, MCP/MCA pod brewers thermal servers and Thermofresh servers (mechanical and digital)- 1 year parts and 1 year labor.
- 2) All other equipment - 2 years parts and 1 year labor plus added warranties as specified below:
 - a) Electronic circuit and/or control boards - parts and labor for 3 years.
 - b) Compressors on refrigeration equipment - 5 years parts and 1 year labor.
 - c) Grinding burrs on coffee grinding equipment to grind coffee to meet original factory screen sieve analysis - parts and labor for 4 years or 40,000 pounds of coffee, whichever comes first.

These warranty periods run from the date of installation BUNN warrants that the equipment manufactured by it will be commercially free of defects in material and workmanship existing at the time of manufacture and appearing within the applicable warranty period. This warranty does not apply to any equipment, component or part that was not manufactured by BUNN or that, in BUNN's judgment, has been affected by misuse, neglect, alteration, improper installation or operation, improper maintenance or repair, non periodic cleaning and descaling, equipment failures related to poor water quality, damage or casualty. In addition, the warranty does not apply to replacement of items subject to normal use including but not limited to user replaceable parts such as seals and gaskets. This warranty is conditioned on the Buyer 1) giving BUNN prompt notice of any claim to be made under this warranty by telephone at (217) 529-6601 or by writing to Post Office Box 3227, Springfield, Illinois 62708-3227; 2) if requested by BUNN, shipping the defective equipment prepaid to an authorized BUNN service location; and 3) receiving prior authorization from BUNN that the defective equipment is under warranty.

THE FOREGOING WARRANTY IS EXCLUSIVE AND IS IN LIEU OF ANY OTHER WARRANTY, WRITTEN OR ORAL, EXPRESS OR IMPLIED, INCLUDING, BUT NOT LIMITED TO, ANY IMPLIED WARRANTY OF EITHER MERCHANTABILITY OR FITNESS FOR A PARTICULAR PURPOSE. The agents, dealers or employees of BUNN are not authorized to make modifications to this warranty or to make additional warranties that are binding on BUNN. Accordingly, statements by such individuals, whether oral or written, do not constitute warranties and should not be relied upon.

If BUNN determines in its sole discretion that the equipment does not conform to the warranty, BUNN, at its exclusive option while the equipment is under warranty, shall either 1) provide at no charge replacement parts and/or labor (during the applicable parts and labor warranty periods specified above) to repair the defective components, provided that this repair is done by a BUNN Authorized Service Representative; or 2) shall replace the equipment or refund the purchase price for the equipment.

THE BUYER'S REMEDY AGAINST BUNN FOR THE BREACH OF ANY OBLIGATION ARISING OUT OF THE SALE OF THIS EQUIPMENT, WHETHER DERIVED FROM WARRANTY OR OTHERWISE, SHALL BE LIMITED, AT BUNN'S SOLE OPTION AS SPECIFIED HEREIN, TO REPAIR, REPLACEMENT OR REFUND.

In no event shall BUNN be liable for any other damage or loss, including, but not limited to, lost profits, lost sales, loss of use of equipment, claims of Buyer's customers, cost of capital, cost of down time, cost of substitute equipment, facilities or services, or any other special, incidental or consequential damages.

392, A Partner You Can Count On, AutoPOD, AXIOM, BrewLOGIC, BrewMETER, Brew Better Not Bitter, BrewWISE, BrewWIZARD, BUNN Espresso, BUNN Family Gourmet, BUNN Gourmet, BUNN Pour-O-Matic, BUNN, BUNN with the stylized red line, BUNNlink, Bunn-O-Matic, Bunn-O-Matic, BUNNserve, BUNNSERVE with the stylized wrench design, Cool Froth, DBC, Dr. Brew stylized Dr. design, Dual, Easy Pour, EasyClear, EasyGard, FlavorGard, Gourmet Ice, Gourmet Juice, High Intensity, iMIX, Infusion Series, Intellisteam, My Café, Phase Brew, PowerLogic, Quality Beverage Equipment Worldwide, Respect Earth, Respect Earth with the stylized leaf and coffee cherry design, Safety-Fresh, savemycoffee.com, Scale-Pro, Silver Series, Single, Smart Funnel, Smart Hopper, SmartWAVE, Soft Heat, SplashGard, The Mark of Quality in Beverage Equipment Worldwide, ThermoFresh, Titan, trifacta, Velocity Brew, Air Brew, Air Infusion, Beverage Bar Creator, Beverage Profit Calculator, Brew better, not bitter., BUNNSource, Coffee At Its Best, Cyclonic Heating System, Daypart, Digital Brewer Control, Element, Nothing Brews Like a BUNN, Pouring Profits, Signature Series, Tea At Its Best, The Horizontal Red Line, Ultra are either trademarks or registered trademarks of Bunn-O-Matic Corporation. The commercial trifacta® brewer housing configuration is a trademark of Bunn-O-Matic Corporation.

INTRODUCTION

This equipment will brew coffee into an awaiting server or airpot. The brewer may have an auxillary hot water faucet. It is only for indoor use on a sturdy and level counter or shelf. Please install in an area where there are no water jet devices.

The Infusion Series, similar to the DBC BrewWISE, incorporates a wireless interface system that allows the MHG or DBC Grinders to load certain information into the "programming chip" located inside the handle of the funnel. This information includes what flavor of coffee is being ground and what batch size will be brewed (half or full). Once the correct flavor name and amount of coffee is ground, the funnel is loaded into the brewer. The information from the funnel handle is then transferred into the brewer. The brewer then takes this information and dispenses the amount of water preset in the brewer for that particular flavor of coffee and batch size. The brewer can also be programmed to adjust different functions of the brewing process, such as brew temperature, brew volumes, bypass percentages, pulse brew, etc. This allows the operator to program a certain "recipe" for each coffee flavor to be brewed.

The Infusion Series Coffee Brewer is able to brew both hot tea and coffee with recipe settings and has the following features: By-Pass, Pre-Infusion and Pulse Brew, BrewWISE, and LCD for digital readout and programming along with the Smart Funnel options for coffee. Other features are Energy Savings mode, BUNNLink compatible, Smart Reader compatible, Freshness Timer and Sanitation Alert.

CONTENTS

Warranty	2
Introduction	3
User Notices	4
Electrical Requirements	5
Plumbing Requirements	6
Tank Drain	6
Operating Controls	7
Initial Set-Up	8
Viewing Assigned Recipes, Asset, & Serial Number	8
Coffee Brewing	9
Cleaning	10
Glossary	10
Programming	12

ICB-DV	Dual Voltage Machine
ICBA	230 Volt Machine
ICBB	200 Volt Machine
ICB Twin	120/208-240V or 2330V

USER NOTICES

Carefully read and follow all notices in this manual and on the equipment. All labels on the equipment should be kept in good condition. Replace any unreadable or damaged labels.

As directed in the International Plumbing Code of the International Code Council and the Food Code Manual of the Food and Drug Administration (FDA), this equipment must be installed with adequate backflow prevention to comply with federal, state and local codes. For models installed outside the U.S.A., you must comply with the applicable Plumbing/Sanitation Code for your area.

#00656.0001

FOR USE ONLY ON AN
INDIVIDUAL BRANCH
CIRCUIT RATED 20 AMPS

#00985.0000



#00658.0000

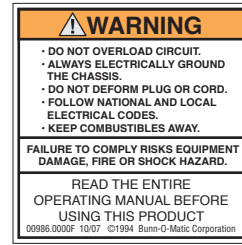

#00986.0000



#03408.0000



#03409.0000



#06064.0000

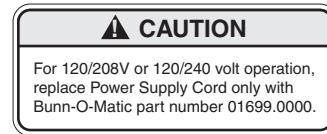

#34072.0000

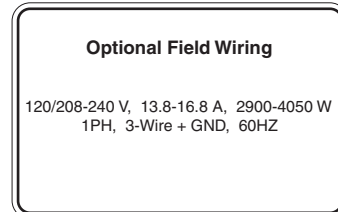

#29710.0011

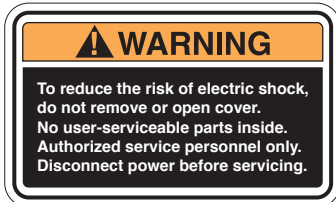

#37881.0000

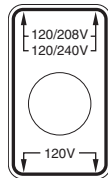

#34056.0001



#00824.0002

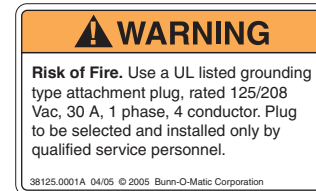

#38125.0001

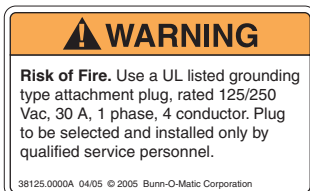

#38125.0000



#00824.0001

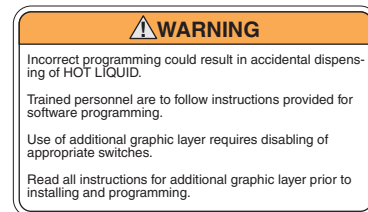

#39175.0000

ELECTRICAL REQUIREMENTS

Refer to Data Plate on the Brewer, and local/national electrical codes to determine circuit requirements.

WARNING - The brewer must be disconnected from the power source until specified.

WARNING - The power cord must be UL Listed, Flexible Cord Type SO, SJO, SJTO, HSJO or SJOW, Rated 90° C, and the attachment plug cap must be UL Listed, in order to avoid a hazard. The Power Supply Cord must be at least 3 feet long and maximum 6 feet long (measured from Strain Relief to end of the Attachment Plug Cap).

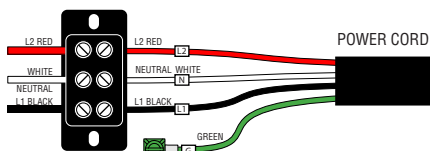

120/208-240V 3 WIRE + GROUND

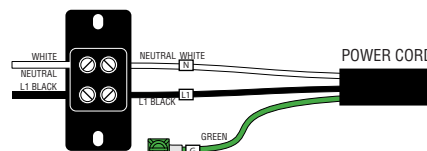

120V 2 WIRE + GROUND

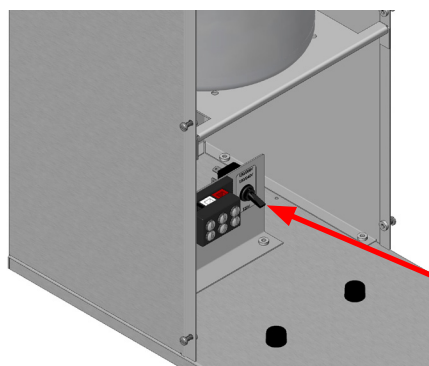

**DUAL VOLT
TOGGLE SWITCH**

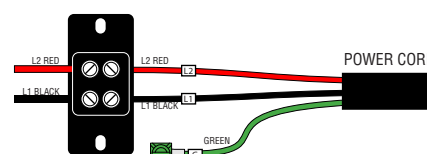

240V 2 WIRE + GROUND

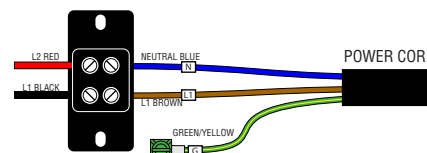

220-240V 2 WIRE + GROUND

ELECTRICAL HOOK-UP (All Models)

CAUTION – Improper electrical installation will damage electronic components. Damage caused by incorrect electrical connections is not covered by warranty.

1. An electrician must provide electrical service.
2. Determine the available on-site electrical service.
3. (DV models only) Select the desired unit voltage based on the available on-site electrical service.
4. Using a voltmeter, check the voltage and color coding of each conductor at the electrical source.
5. Remove the front access panel to gain access to the terminal block.
6. Feed the power cord through the strain relief and connect it to the terminal block(s).
7. Connect the power cord to the terminal block as shown.
8. Before proceeding, verify the voltage at the field wiring terminal block.
9. (DV models only) Set voltage switch to the appropriate position and replace the access panel.
10. If plumbing is to be hooked up later be sure the brewer is disconnected from the power source. If plumbing has been hooked up, the brewer is ready for Initial Set-Up.

CE Requirements:

- This appliance must be installed in locations where it can be overseen by trained personnel.
- For proper operation, this appliance must be installed where the temperature is between 5°C to 35°C.
- Appliance shall not be tilted more than 10° for safe operation.
- An electrician must provide electrical service as specified in conformance with all local and national codes.
- This appliance must not be cleaned by water jet.
- This appliance is not intended for use by persons (including children) with reduced physical, sensory or mental capabilities, or lack of experience and knowledge, unless they have been given instructions concerning use of this appliance by a person responsible for its safety.
- Children should be supervised to ensure they do not play with the appliance.
- If the power cord is ever damaged, it must be replaced by the manufacturer or authorized service personnel with a special cord available from the manufacturer or its authorized service personnel in order to avoid a hazard.
- Machine must not be immersed for cleaning.

PLUMBING REQUIREMENTS

These brewers must be connected to a cold water system with operating pressure between 20 and 90 psi (138 and 620 kPa) from a 1/2" or larger supply line. A shut-off valve should be installed in the line before the brewer. Install a regulator in the line when pressure is greater than 90 psi (620 kPa) to reduce it to 50 psi (345 kPa). The water inlet fitting is .75-11.5 NH (HOSE THREAD). For convenience an elbow adaptor is provided to convert to a 1/4" flare fitting. Bunn-O-Matic does not recommend the use of a reverse-osmosis or deionized water supply to this equipment. **REQUIRED: 1.0 gpm (3.78 lpm) flow rate from water supply line.**

NOTE - Bunn-O-Matic recommends 3/8" copper tubing for all installations from the 1/2" water supply line. A tight coil of tubing in the water line will facilitate moving the brewer to clean the countertop. Bunn-O-Matic does not recommend the use of a saddle valve to install the brewer. The size and shape of the hole made in the supply line by this type of device may restrict water flow.

As directed in the International Plumbing Code of the International Code Council and the Food Code Manual of the Food and Drug Administration (FDA), this equipment must be installed with adequate backflow prevention to comply with federal, state and local codes. For models installed outside the U.S.A., you must comply with the applicable Plumbing /Sanitation Code for your area.

Plumbing Hook-Up

1. Flush the water line.
2. Securely attach the adaptor elbow assembly to the water supply line.
3. Securely attach adaptor elbow assembly to the the .75-11.5 NH (HOSE THREAD) fitting at the rear of the brewer.
4. Turn on the water supply.

TANK DRAIN

1. Loosen screws that secure the front access panel. Remove the panel.
2. Tighten the white shutoff clamp on the long hose between tank and inlet solenoid.
2. Disconnect the hose clamp and hose from inlet solenoid.
3. Place the end of the drain hose in a container that has a minimum capacity of [3.5 gallons/13.25 L Singles] [6.0 gallons/22.7 L-Twins].
4. Release the white clamp to drain water from the tank.
5. When tank is empty, replace the hose onto solenoid, and tighten the clamp.
6. Replace the front panel and tighten screws.

OPERATING CONTROLS

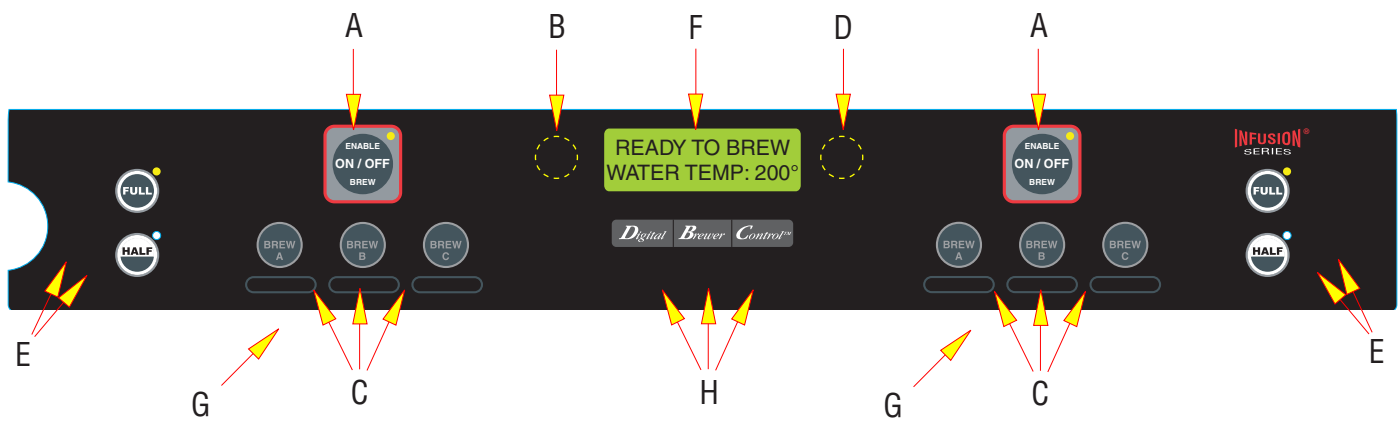

A. ENABLE BREW ON/OFF SWITCH

Pressing the "ENABLE BREW ON/OFF" switch (indicator on) enables the brew circuit (on that side of Twins), and energizes the tank refill circuit. Pressing the switch again (indicator off) stops tank refilling and brewing. Stopping a brew cycle after it has been started will not stop the flow of water into the server until the funnel is empty. Pressing this switch during programming of the brewer will exit the setup and return to the main screen.

NOTE – For Singles, refer to left side of Twins

NOTE – Hot water will be available at the faucet in a limited amount when the "ENABLE BREW ON/OFF" switch is in the "OFF" position because the tank will not refill.

B. PROGRAMMING (left)

This hidden switch can be used to scroll backwards through the function list while in programming mode.

C. BREW (A,B,C)

When the "ENABLE BREW ON/OFF" switch is ON and the main screen is visible, momentarily pressing and releasing this switch will begin a brew cycle on the selected side.

D. PROGRAMMING (right)

Pressing and holding this switch allows entry into the programming menus. Pressing and releasing the switch steps through each function screen while in the programming mode.

E. BATCH SELECTOR SWITCHES

Pressing the switch corresponding to the Half or Full batch selects the amount of product to be brewed on the selected side. Pressing a different switch after a brew cycle has been initiated does not change the brew batch in progress. Light indicates the selected batch to brew. Also used in programming to adjust settings on both batch sizes.

F. FUNCTION SCREEN

This is the display which shows the various functions of the brewer and allows the programming to be accomplished.

G. FUNNEL SENSING COIL

These are used to "receive" information from the Smart Funnel handle, recipe cards, and ad cards.

H. FUNCTION SCREEN SWITCHES

Digital: This is used to select options (NO/-) that appear on the display during programming.

Brewer: This is used to select options (DONE) that appear on the display during programming.

Control: This is used to select options (YES/+) that appear on the display during programming.

INITIAL SET-UP

1. Insert an empty funnel into the funnel rails of the brew station(s).
2. Place an empty server(s) under the funnel(s).
3. Connect the brewer to the power source. Make sure the corresponding "ENABLE BREW ON/OFF" switch is ON (LED will be lit).
4. Water will flow into the tank and stop when the tank is filled to its capacity. Display will show **PLEASE WAIT... TANK FILLING** until tank is filled with water.
5. Wait approximately twenty-five minutes for the water in the tank to heat to the proper temperature. Display will show **READY TO BREW...WATER TEMP: 200°** when tank is at operating temperature. Some water may drip from the funnels during this time; this is due to expansion and should not occur thereafter.
6. Place a small vessel beneath the faucet and open the faucet handle. Release it when you hear the tank refilling.
7. Water volumes and flow settings have been preset at the factory. Refer to programming manual should the volume need to be increased or decreased.
8. The brewer is now ready for use in accordance with the instructions for Coffee Brewing.

Brew water temperature is factory set at 200° F (93.3° C) Areas of high altitude will require lowering this temperature to prevent boiling. This chart should be used as a guide when readjusting the brew water temperature.

Altitude (Feet)	Boiling point of water		Recommended water temperature	
	° F	° C	° F	° C
-1000	213.8	101.0	200	93.3
-500	212.9	100.5	200	93.3
0	212.0	100.0	200	93.3
500	211.1	99.5	200	93.3
1000	210.2	99.0	200	93.3
1500	209.3	98.5	200	93.3
2000	208.4	98.0	200	93.3
2500	207.4	97.4	200	93.3
3000	206.5	96.9	199	92.8
3500	205.6	96.4	198	92.2
4000	204.7	95.9	197	91.7
4500	203.8	95.4	196	91.1
5000	202.9	94.9	195	90.6
5500	201.9	94.4	195	90.6
6000	201.0	93.9	194	90.0
6500	200.1	93.4	193	89.4
7000	199.2	92.9	192	88.9
7500	198.3	92.4	191	88.3
8000	197.4	91.9	190	87.8
8500	196.5	91.4	189	87.2
9000	195.5	90.8	188	86.7
9500	194.6	90.3	187	86.1
10000	193.7	89.8	186	85.6

VIEWING ASSIGNED RECIPES, ASSET & SERIAL NUMBER

1. Make sure the "ENABLE BREW ON/OFF" switch is OFF (LED will not be lit).
2. Press and hold "BREW A" switch. The display will show the name of the recipe assigned to Brew A along with "SWITCH NOT ON". This is to indicate that a brew cannot be initiated while the "ENABLE BREW ON/OFF" switch is OFF on this side.
3. Repeat for BREW B and BREW C.
4. (Twins only) Repeat steps 1 -3 for other side.
5. Make sure the "ENABLE BREW ON/OFF" switch is OFF. To view the asset number of the machine, press and hold the left hidden button until the display reads: **ANXXXXXX...ASSET NUMBER**. Release the left hidden button.
6. After a 5 second delay, the display will read: **ICBXXXXXXX**. This is the serial number of the machine.

COFFEE BREWING

WITHOUT A SMART FUNNEL AND MHG or DBC GRINDER:

1. Begin each brew cycle with a clean empty brew funnel.
2. Insert a BUNN filter into the funnel.
3. Pour the fresh coffee into the filter and level the bed of grounds by gently shaking.
4. Slide the funnel into the funnel rails of the selected side until it stops.
5. Place an empty server under the funnel.
6. The "ENABLE BREW ON/OFF" switch for the selected side must be ON. Select the desired batch size.
7. Momentarily press and release the assigned BREW button. There may be certain situations in which the brew cycle will not begin when BREW is pressed:
 - a. **SWITCH NOT ON** - "ENABLE BREW ON/OFF" switch must be ON.
 - b. **BREW TEMPERATURE TOO LOW** - wait until heated, or cancel **BREW LOCKOUT** option.
 - c. **CHECK FUNNEL** - remove funnel, empty previously brewed grounds and replace with fresh.
 - d. **DISABLED** - select different brew button or batch size.
8. If none of the above messages are displayed, the display will read **NOW BREWING** and show the time remaining in the brew cycle.
9. Following the brew will be a countdown of drip time **DRIPPING** which shows the time remaining until the coffee no longer drips from the funnel tip.
10. Carefully remove the brew funnel and discard the grounds and filter only after visible dripping stops.

WITH A SMART FUNNEL AND G9-2T DBC or MHG GRINDER:

1. Select the small batch size on the grinder.
2. Insert a BUNN filter into the funnel.
3. Grind the selected amount of fresh coffee into the Smart Funnel using the G9-2T DBC or MHG with Smart Funnel operation and level the grounds by gently shaking.
4. Slide the funnel into the funnel rails of the selected side. The brewer will read the coffee name and size ground through the chip in the funnel handle.

NOTE - The brewer will automatically match the brew batch size to the grinder batch size:

<u>GRINDER</u>	<u>BREWER</u>
Small	Half Batch
Medium	Full Batch
Large	*Full Batch

*If BREW is pressed with a large grinder batch, the display will read: **INCORRECT GRIND...BATCH SIZE WRONG**, and then **PRESS BREW TO BREW ANYWAY**.

5. Place an empty server under the funnel.
6. The "ENABLE BREW ON/OFF" switch for the selected side must be ON.
7. Momentarily press and release the assigned BREW button. There may be certain situations in which the brew cycle will not begin when BREW is pressed:
 - a. **SWITCH NOT ON** - "ENABLE BREW ON/OFF" switch must be ON.
 - b. **BREW TEMPERATURE TOO LOW** - wait until heated or cancel **BREW LOCKOUT** option.
 - c. **CHECK FUNNEL** - remove funnel, empty previously brewed grounds and replace with fresh.
 - d. **INCORRECT GRIND** - Indicates a large batch was ground using the grinder. Check batch size.
8. If none of the above messages are displayed, the display will read **NOW BREWING** and show the time remaining in the brew cycle. Arrows will point to the side that is brewing. If both sides are brewing simultaneously, the arrows will alternate from left to right on the display.
9. Following the brew will be a countdown of drip time **DRIPPING** which shows the time remaining until the coffee no longer drips from the funnel tip.
10. Carefully remove the brew funnel and discard the grounds and filter only after visible dripping stops.

CLEANING

1. The use of a damp cloth rinsed in any mild, nonabrasive, liquid detergent is recommended for cleaning all surfaces on Bunn-O-Matic equipment. Do **NOT** clean this equipment with a water jet device.
2. Check and clean each sprayhead. The sprayhead holes must always remain open.

NOTE - Any buildup on the sprayhead may restrict water flow, and impact your coffee brewing. For consistently great coffee, clean sprayheads weekly. Upon visual inspection it may appear that light passes through all holes in the sprayhead plate, but a thin film of residue can pass light and still impede water flow.

3. Remove sprayhead from brewer. Disassemble by removing the seal.
4. Use the pointed end of sprayhead cleaning tool to remove any mineral deposits from the sprayhead holes.
5. Insert the long end of sprayhead cleaning tool into the sprayhead fitting, and rotate several times to remove any mineral deposits from the fitting.
6. Insert the short end of sprayhead cleaning tool into the bypass fittings, and rotate several times to remove any mineral deposits from the fitting.
7. Reassemble sprayhead and reattach. Sprayhead only needs to be hand tightened.

Refer to programming manual for calibration routine to verify sprayhead flow rate matches programmed flow rate. Machine may need to be re-calibrated due to lime build up. If machine is cleaned and build up removed, machine must be re-calibrated to achieve desired volumes.

PROGRAMMING

The programming of the brewer is divided into two levels. There is one function in Level 1. All other functions are accessed in Level 2.

The following function screens are in order of appearance. Each screen will have instructions on how to access and the procedures for programming the various functions of the brewer.

IMPORTANT PROGRAMMING NOTES - READ CAREFULLY -

To exit the programming mode at any time, press and release either ON/OFF pad located on the front switch panel. The display will return to the **MAIN SCREEN**.

If none of the five programming switches are pressed within one minute during the setup of the brewer, the programming of the function screen that is being set will be exited and the display will return to the **MAIN SCREEN**.

Always remember to place a container and funnel under the sprayhead when operating the brewer during the set-up of **CALIBRATE FLOW**, and testing the brew and bypass valves in **SERVICE TOOLS/TEST OUTPUTS**.

MAIN SCREEN

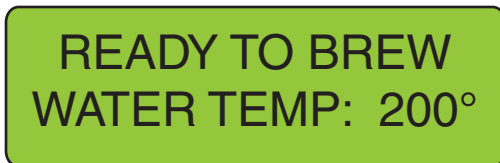

P2426

This screen will be shown when the brewer is ready for use. The screen displays the water temperature in the tank. When the water in the tank reaches the correct set temperature, the display will change from **HEATING** to **READY TO BREW**.

PROGRAMMING LOCKOUT SWITCH (located on the memory module board prior to S/N ICB001330 - located on the main circuit board S/N ICB001330 and after)

This switch can be set to prevent access to the programming settings of the brewer. Once all the correct brew settings are programmed, the operator can set the switch to the "ON" position to prohibit anyone from changing the settings. With the switch in the "ON" position, the programming menus can still be accessed to view the current settings. However, no changes will be saved.



For additional information, you can download the programming manual at www.bunn.com

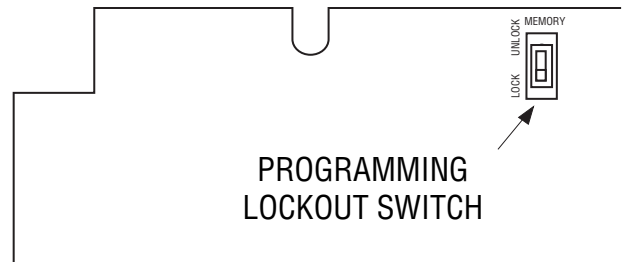

P3048

For more advanced PROGRAMMING information, refer to programming manual 41581.0001 at www.bunn.com

PROGRAMMING (cont.)

PROGRAMMING FUNCTIONS - FLOW CHART

PROGRAMMING FUNCTIONS - LEVEL 1

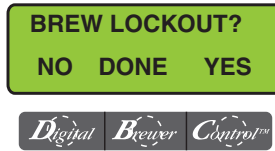

PROGRAMMING FUNCTIONS - LEVEL 2

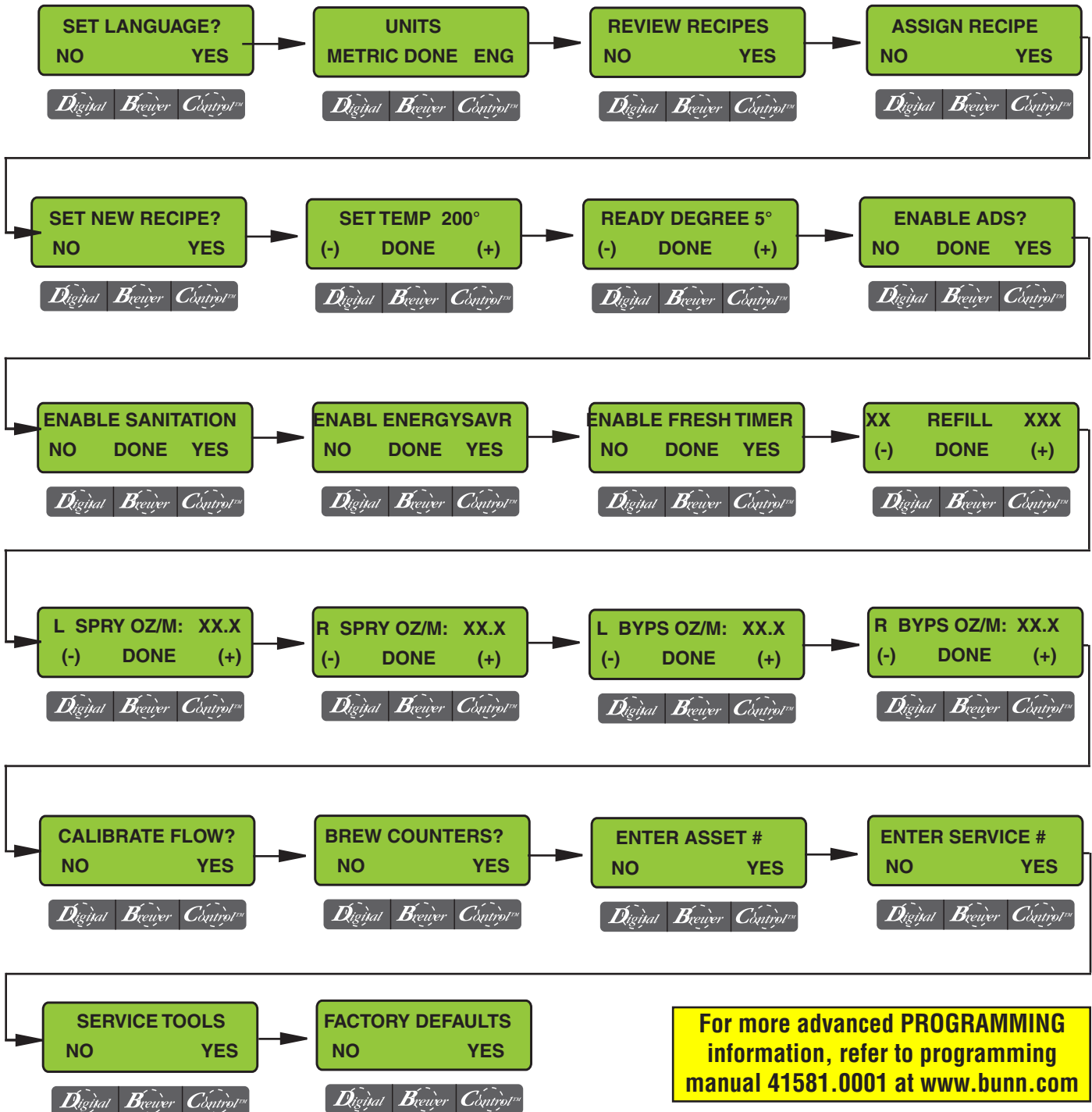

For more advanced PROGRAMMING information, refer to programming manual 41581.0001 at www.bunn.com