

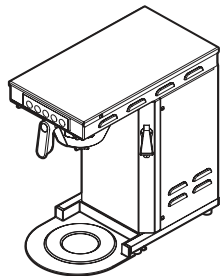

Service Manual – TLP Brewer



MODEL • TLP



CAUTION: Please use this setup procedure before attempting to use this brewer. Failure to follow the instructions can result in injury or the voiding of the warranty.



CAUTION: DO NOT connect this brewer to hot water. The inlet valve is not rated for hot water.



IMPORTANT: This equipment is to be installed to comply with the applicable federal, state, or local plumbing and electrical codes having jurisdiction.



WARNING: To avoid scalding, do NOT remove brew cone while brew indicator light is flashing.



IMPORTANT: The brewcycle is adjusted at the factory to fill a standard 2.5 liter airpot with 2.2 liters of brewed coffee. The duration of the brewcycle is set from 3 to 4 minutes.



ISO 9001:2008 REGISTERED

WILBUR CURTIS CO., INC. 6913 West Acco Street Montebello, CA 90640-5403 For the latest information go to www.wilburcurtis.com Tel: 800-421-6150 Fax: 323-837-2410

Important Safeguards/Symbols

This equipment is designed for commercial use. Any servicing other than cleaning and routine maintenance should be performed by an authorized Wilbur Curtis Company Service Technician.

- DO NOT immerse the unit in water or any other liquid
• To reduce the risk of fire or electric shock, DO NOT open service panels. There are no user serviceable parts inside.
• Keep hands and other items away from hot areas of the unit during operation.
• Never clean with scouring powders or harsh chemicals.

Symbols



WARNINGS – To help avoid personal injury



Important Notes/Cautions – from the factory



Sanitation Requirements

System Requirements

- Water Source: 20 - 100 PSI. Must have a Minimum Flow Rate of 1/2 GPM (preferred flow rate is 1 gpm).
• Electrical: See attached schematic for your model.

Setup Steps

1. The unit should be level (left to right - front to back), on a secure surface.
2. Connect the water line to the water inlet fitting on the rear of the unit. Water volume flow to the machine should be consistent. Use tubing sized sufficiently to provide a minimum flow rate of one gallon per minute.



NSF International requires the following water connection:

1. A quick disconnect or additional coiled tubing (at least 2x the depth of the unit) is required so that the unit can be moved for cleaning.
2. This unit must be installed with adequate backflow protection to comply with applicable federal, state and local codes.
3. Water pipe connections and fixtures directly connected to a potable water supply shall be sized, installed and maintained in accordance with federal, state, and local codes.

3. Connect the unit to electrical outlet with appropriate amperage rating (see serial tag on machine). Once power has been supplied to the unit, flip the toggle switch to the 'ON' position (located on the rear of the unit), the water tank will begin to fill. When the water level in the tank reaches the probe, the heating element will turn on.
4. Turn on the control panel by pressing the ON/OFF button.
5. The heating tank will require 20 to 30 minutes to reach operating temperature (200°F). The READY-TO-BREW light will come on.
6. Prior to brewing, dispense 12 ounces of hot water through the hot water faucet.
7. Run brew cycle of at least 16 ounces to purge the water line of any air trapped in the lines after filling.

Brewing Coffee

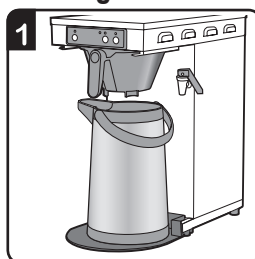

1. Place a clean, empty airpot in position, centered under the brew cone.

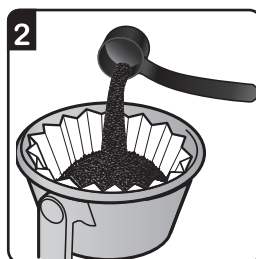

2. Place a new filter into the brewcone. Pour the proper amount of ground coffee into the filter.

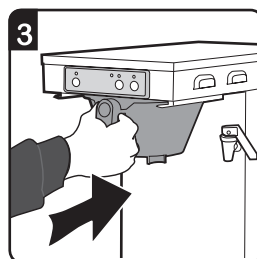

3. Slide the brewcone into position on brew rails.



4. Press the BREW button. The indicator light above the selected brew button will flash during the brew-cycle.

# STEPS TO PROGRAMMING

Your Curtis TLP system is factory pre-set for optimum performance. Generally, there will not be a need to change programming.

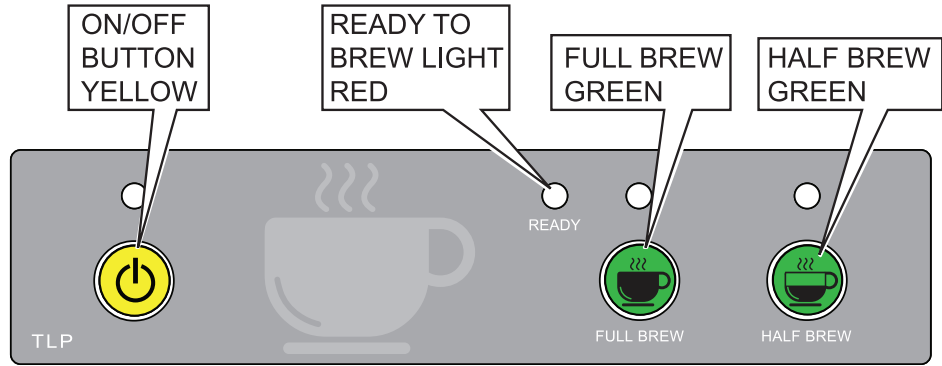

**CAUTION:** These steps involve working with hot water. Avoid against splashing and spilling.

## Changing the TLP Program

The TLP features a dynamic memory. In the event of a power loss, it will remember ALL program settings.

Brew Temperature – Factory Pre-Set to 200°F

Function to set brew temperature, 170° to 206°F. Brew temperature will be indicated by READY-TO-BREW light blinking.







### ENTERING THE PROGRAM MODE #1

For ALL functions you must first enter the programming mode.

- Turn OFF the power from the Control Panel by pressing  .
- Press and HOLD  and press and RELEASE  .
- Continue HOLDING until  starts blinking; RELEASE.

### CONFIRM/RESET BREW TEMPERATURE - Factory Preset to 200°F

ENTER THE PROGRAMMING MODE #1:

- Press  for two seconds, then RELEASE.
-  will start blinking. Each blink equals 2° F, starting at 170° (max. temp. 206° F or 19 blinks).
- To change Temperature, press and HOLD  .
-  will start QUICK flashing. Each QUICK flash equals 2° F. After reaching 206°, temperature starts over at 170°.
- RELEASE  when the desired temperature is reached (new temp. will now be displayed).
- To set and exit, press  .

### Temperature Table

N° of Blinks	Temp.	N° of Blinks	Temp.
1	170° F	11	190° F
2	172° F	12	192° F
3	174° F	13	194° F
4	176° F	14	196° F
5	178° F	15	198° F
6	180° F	16	200° F
7	182° F	17	202° F
8	184° F	18	204° F
9	186° F	19	206° F
10	188° F		

## Brew Volume - Factory Pre-set Full Brew to 2.2 Liters

When setting the brew volume, place an empty airpot under the brewcone to determine volume level. The factory default for the Half Brew button is half the brew volume of the Full Brew button. The brew volume of the Half Brew button can be set independently (see Half Brew Volume below).



Before changing the brew volume, wait until unit reaches brew temperature (Ready to Brew light comes on), insert the brewcone into place on the brewer, then place an airpot or some kind of measuring container centered beneath the brewcone.

## CHANGE FULL BREW VOLUME

### ENTER THE PROGRAMMING MODE #1

(Be sure to have an empty brewcone & airpot in position).

- Press and HOLD  until hot water starts running from sprayhead; then RELEASE.
- When desired volume is reached, press  again to stop flow and set brew volume.

## HALF BREW VOLUME

### ENTER THE PROGRAMMING MODE #1

Have an empty brewcone & airpot in position under the sprayhead.

- Press and HOLD  until hot water starts running from sprayhead; then RELEASE.
- When desired volume is reached, press  again to stop flow and set brew volume.

## BREW CYCLE COUNTER

### ENTER THE PROGRAM MODE #2

- Turn OFF the power from the Control Panel by pressing  .
- Press and HOLD  and press and RELEASE .
- Continue HOLDING  until  STOPS blinking; RELEASE.







### TO ACCESS BREW CYCLE COUNTER

#### ENTER THE PROGRAMMING MODE #2:

-  will now start a pattern of LONG and SHORT blinks. This pattern identifies the number of brew cycles. SHORT blinks indicate the brew number from one [1] to nine [9]. LONG blinks separate the 1's, 10's, 1,000's and 10,000's.





## PULSE BREW

### ENTER THE PROGRAM MODE #3

- Turn OFF the power from the Control Panel by pressing  .
- Press and HOLD  and press and RELEASE .
- Continue HOLDING  until  STOPS blinking and remains on, then RELEASE .
-  will now blink one of three different flashing light patterns (refer to Pulse Options, right).

### CHANGING THE PULSE BREW FEATURE

To change:

- Press and HOLD  until  shows one quick flash, then RELEASE. You have now added a blink to your blinking light pattern.
- By pressing and holding  you add another blink.
- To set and exit, press .

#### PULSE OPTIONS:

OFF = One Long Flash (Factory Default)

#1 = One Long Flash + 1 Short Flash → 

#2 = One Long Flash + 2 Short Flash → 

#3 = One Long Flash + 3 Short Flash → 

**Option #1** produces a pulse of 40 seconds ON, 40 seconds OFF, then ON until the end of the brew cycle.

**Option #2** provides a pulse of 30 seconds ON, 5 seconds OFF, repeated four times, then continuously ON until the end of the brew cycle.

**Option #3** is 40 seconds ON, 40 seconds OFF, 60 seconds ON, 25 seconds OFF, then ON until the end of the brew cycle.

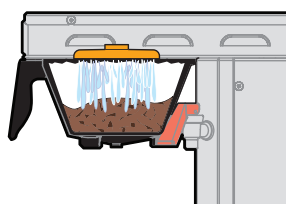

ON

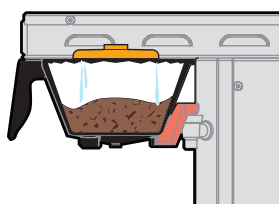

OFF

# ERROR CODES

ADS technology features a state-of-the-art error code system. This is designed to quickly advise you of any problems the system may experience expediting service or repair. Occasionally, an error reported may be a problem with the water supply or electrical power; NOT directly associated with a fault of the Curtis system itself. An example of this includes a clogged water filter — indicated by a water level error code.

**IMPORTANT** Error Codes are reset by turning the rear toggle switch to Standby for a minimum of 10 seconds, then returning the switch to ON. Any service required for your Curtis system must be performed by a qualified service technician.

Error Codes are indicated by  blinking.  
 = Long Flash     = Short Flash

The code pattern is as follows:

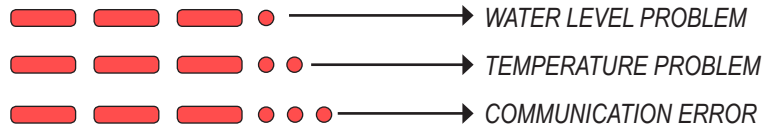

## PARTS LIST

ITEM N°	PART N°	DESCRIPTION
1	WC-3418	BREW CONE, ASSY W/SPLASH POCKET STYLIZED
1A	WC-3316	BREWCONE W/BASKET, S/S STD 7 1/8
2	WC-61336	COVER, TOP TLP BLACK TEXTURE
2A	WC-61355	COVER, TOP SS TLP
3	WC-2962-101K	KIT, FITTING SPRAYHEAD KYNAR
4	WC-39662	* LABEL, CONTROL PANEL TLP
5	WC- 717	* CONTROL BOARD, SMART CARD SWITCH PANEL
6	WC-29030	* SPRAYHEAD ASSY, ADVANCED FLOW ORANGE
7	WC-3503	* LEG, SCREW BUMPER 3/8" - 16 STUD
8	WC-3765L	* KIT, INLET VALVE REPAIR (FOR WC-826L, WC-847)
9	WC- 715	* CONTROL MODULE, TLP 120V 16PIN
10	WC- 102	* SWITCH, TOGGLE SPST 25A 250VAC RESISTIVE
11	WC-2401	* ELBOW, 3/8 NPT X 1/4 FLARE PLATED
12	WC-61335	COVER, SIDE TLP BLACK TEXTURE 18"
12A	WC-61335-101	COVER, SIDE LEFT TLP 18"
12B	WC-61354	COVER, SIDE SS TLP 18"
13	WC-1040	* PUMP, WATER CENTRIFUGAL 120V 60 Hz
14	WC-1809	FAUCET, PS/HPS SERIES HOT WATER 1/2-20 UNF AP/ALP
15	WC- 826L	* VALVE INLET 1GPM 120V 10W
16	WC-5310	* TUBE, 5/16 ID x 1/8W SILICONE
17	WC-8591	* CAPACITOR, X2
18	WC-54314	TANK, ASSY 120V TLP12/20 1450W
18A	WC-54314-101	TANK, ASSY 120V TLP12/20 1450W FOR TLP 300 LEFT
19	WC-43062	* GASKET, TANK
20	WC-5853-102	COVER, TOP HEATING TANK GEN USE
21	WC-5502-01	* KIT, PROBE, ASSY WATER LEVEL W/HEX FITTING, O-RING & NUT
22	WC- 917-04	* ELEMENT, HEATING 1.45KW 120V W/JAM NUTS & SILICONE WASHERS
23	WC- 523	* THERMOSTAT, MANUAL RESET 120/220 VAC 25A 220 DEG F MAX
24	WC-5227	* COMPOUND, SILICONE 5 OZ TUBE
25	WC-1438-101	* SENSOR, HEATING TANK
26	WC-66050	DRIP TRAY, TLP
27	WC-1806	* SEAT CUP, SILICONE
28	WC-4320	O-RING, 1/2" I.D.

\* SUGGESTED PARTS LIST

# PARTS DIAGRAMS

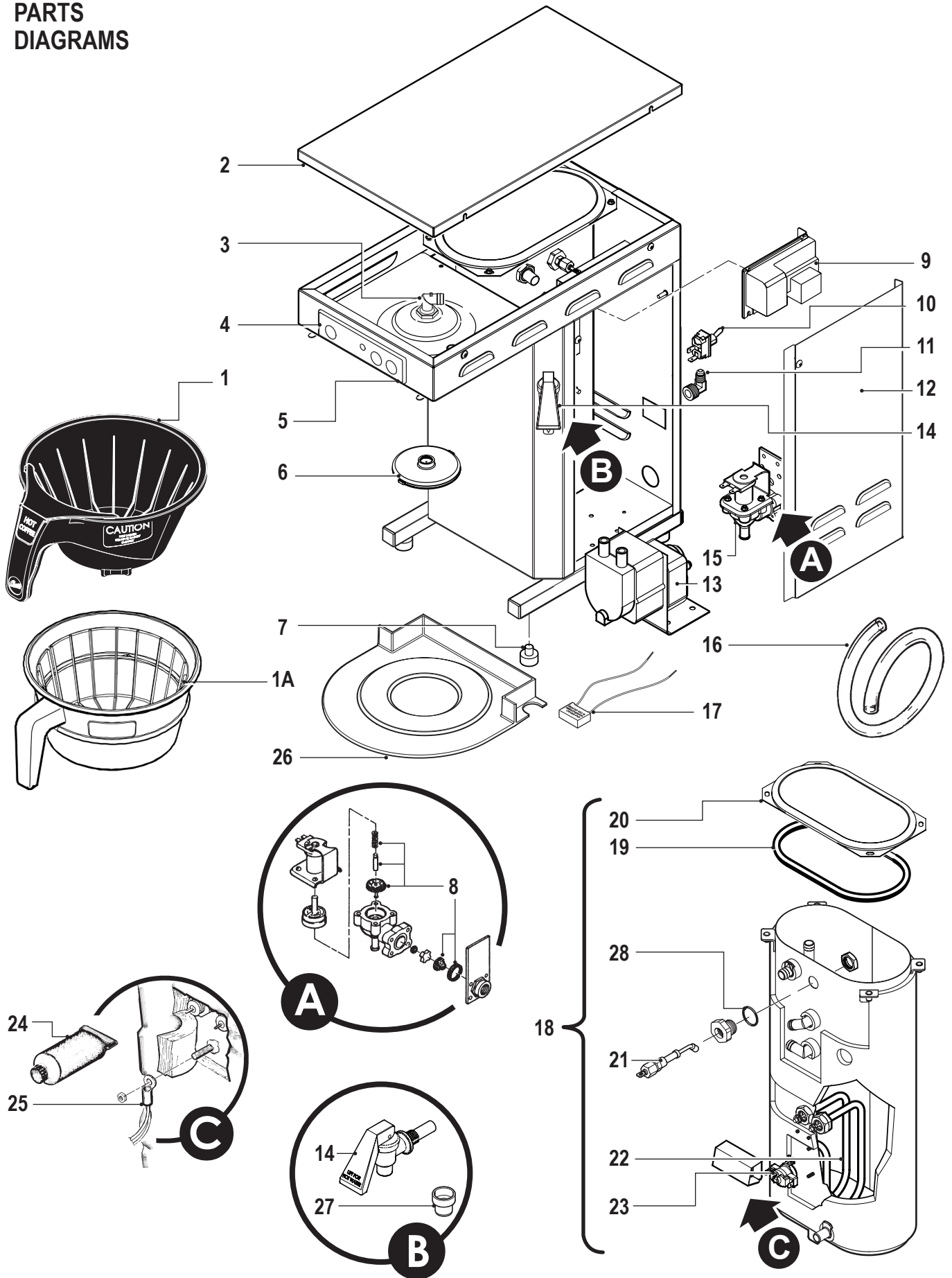

# ELECTRICAL SCHEMATIC

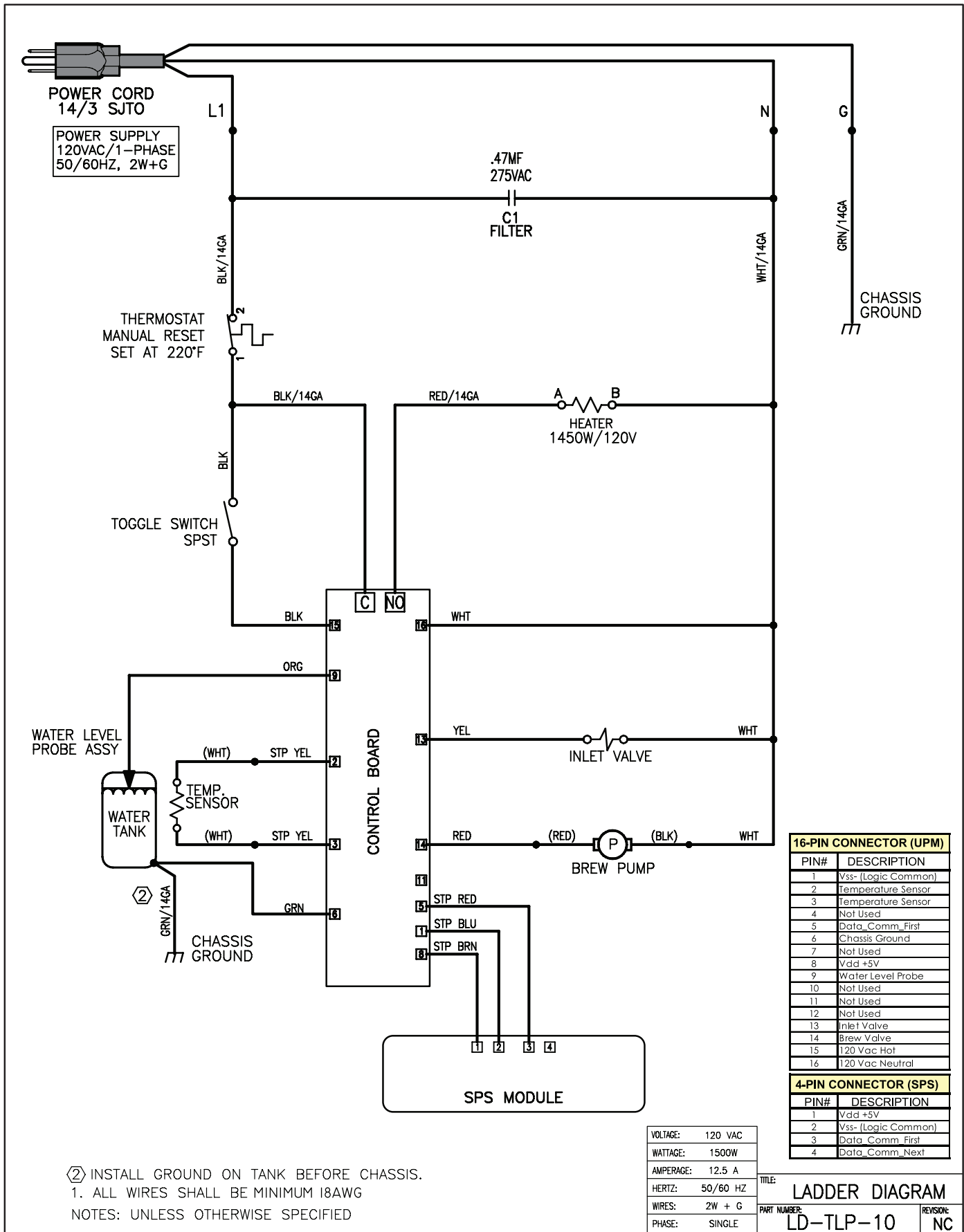

---

## Cleaning the Coffee Brewer

Regular cleaning and preventive maintenance is essential in keeping your coffee brewer looking and working like new.



**CAUTION** – Do not use cleansers, bleach liquids, powders or any other substance containing chlorine. These products promote corrosion and will pit the stainless steel. USE OF THESE PRODUCTS WILL VOID THE WARRANTY.

1. Wipe exterior surfaces with a moist cloth, removing spills and debris.
2. Slide the brewcone out and clean it. Clean the sprayhead area with a moist clean cloth.
3. Rinse and dry the brewcone.
4. Drain drip tray of coffee. Wash out the drip tray. Dry the tray.
5. Rub a stainless steel polish on the outside surfaces to protect the brewer.

## Cleaning the Insulated Carafe

To clean the coffee carafe, prepare a mild solution of detergent and warm water.

1. Wipe exterior surfaces with a moist cloth, removing water spots and dried coffee.
2. Remove lid and clean inside the funnel tube with a detergent solution.
3. Use a sponge, brush soaked in detergent solution, to clean the inside of the carafe liner. Scrub with the sponge brush to remove all coffee residue.
4. Thoroughly rinse out the carafe and lid with clean warm water.
5. Dry and assemble the coffee server.

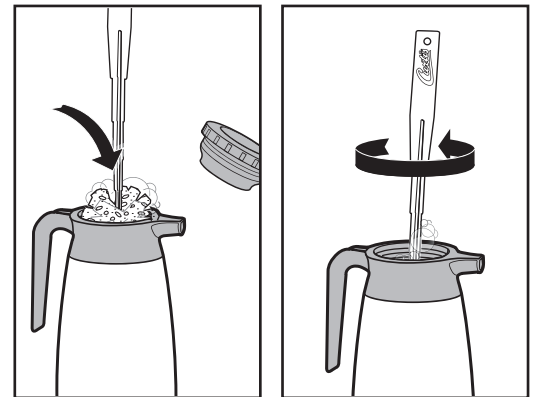

**DO NOT immerse the coffee carafe in water. DO NOT place in dishwasher.**

## Cleaning Airpots

1. Wipe exterior surfaces with a moist cloth, removing water spots and dried coffee.
2. Clean the airpot with a mild solution of detergent and warm water. Use a sponge cleaning brush to scrub inside.
3. Clean the syphon tube/funnel with a detergent solution.
4. Rinse thoroughly with warm water.

**DO NOT immerse airpots in water. DO NOT place in dishwasher.**

## Filter Pouch Cleaner

You may use a filter pouch cleaner to easily clean both the brew cone and the coffee vessel.

1. Place a pouch cleaner into the brew cone. Place an empty server on the brew deck.
2. Press the brew button to run a full brew cycle into the server.
3. At the end of the brew cycle, discard the used filter cleaner pouch.
4. Allow the cleaner to soak in the coffee server for 10 minutes.
5. Dump out the cleaner from the coffee server into a sink.
6. Return the empty coffee server to the brew deck and run another brew cycle to run hot water through the brew cone and into the server.
7. Empty the rinse water from the coffee server.

## Product Warranty Information

The Wilbur Curtis Company certifies that its products are free from defects in material and workmanship under normal use. The following limited warranties and conditions apply:

3 Years, Parts and Labor, from Original Date of Purchase on digital control boards.

2 Years, Parts, from Original Date of Purchase on all other electrical components, fittings and tubing.

1 Year, Labor, from Original Date of Purchase on all electrical components, fittings and tubing.

Additionally, the Wilbur Curtis Company warrants its Grinding Burrs for Forty (40) months from date of purchase or 40,000 pounds of coffee, whichever comes first. Stainless Steel components are warranted for two (2) years from date of purchase against leaking or pitting and replacement parts are warranted for ninety (90) days from date of purchase or for the remainder of the limited warranty period of the equipment in which the component is installed.

All in-warranty service calls must have prior authorization. For Authorization, call the Technical Support Department at 1-800-995-0417. Effective date of this policy is April 1, 2003.

Additional conditions may apply. Go to [www.wilburcurtis.com](http://www.wilburcurtis.com) to view the full product warranty information.

### CONDITIONS & EXCEPTIONS

The warranty covers original equipment at time of purchase only. The Wilbur Curtis Company, Inc., assumes no responsibility for substitute replacement parts installed on Curtis equipment that have not been purchased from the Wilbur Curtis Company, Inc. The Wilbur Curtis Company will not accept any responsibility if the following conditions are not met. The warranty does not cover and is void under the following circumstances:

- 1) Improper operation of equipment: The equipment must be used for its designed and intended purpose and function.
- 2) Improper installation of equipment: This equipment must be installed by a professional technician and must comply with all local electrical, mechanical and plumbing codes.
- 3) Improper voltage: Equipment must be installed at the voltage stated on the serial plate supplied with this equipment.
- 4) Improper water supply: This includes, but is not limited to, excessive or low water pressure, and inadequate or fluctuating water flow rate.
- 5) Adjustments and cleaning: The resetting of safety thermostats and circuit breakers, programming and temperature adjustments are the responsibility of the equipment owner. The owner is responsible for proper cleaning and regular maintenance of this equipment.
- 6) Damaged in transit: Equipment damaged in transit is the responsibility of the freight company and a claim should be made with the carrier.
- 7) Abuse or neglect (including failure to periodically clean or remove lime accumulations): Manufacturer is not responsible for variation in equipment operation due to excessive lime or local water conditions. The equipment must be maintained according to the manufacturer's recommendations.
- 8) Replacement of items subject to normal use and wear: This shall include, but is not limited to, light bulbs, shear disks, "O" rings, gaskets, silicone tube, canister assemblies, whipper chambers and plates, mixing bowls, agitation assemblies and whipper propellers.
- 9) Repairs and/or Replacements are subject to our decision that the workmanship or parts were faulty and the defects showed up under normal use. All labor shall be performed during regular working hours. Overtime charges are the responsibility of the owner. Charges incurred by delays, waiting time, or operating restrictions that hinder the service technician's ability to perform service is the responsibility of the owner of the equipment. This includes institutional and correctional facilities. The Wilbur Curtis Company will allow up to 100 miles, round trip, per in-warranty service call.

**RETURN MERCHANDISE AUTHORIZATION:** All claims under this warranty must be submitted to the Wilbur Curtis Company Technical Support Department prior to performing any repair work or return of this equipment to the factory. All returned equipment must be repackaged properly in the original carton. No units will be accepted if they are damaged in transit due to improper packaging. **NO UNITS OR PARTS WILL BE ACCEPTED WITHOUT A RETURN MERCHANDISE AUTHORIZATION (RMA). RMA NUMBER MUST BE MARKED ON THE CARTON OR SHIPPING LABEL.** All in-warranty service calls must be performed by an authorized service agent. Call the Wilbur Curtis Technical Support Department to find an agent near you.

7/12/12@9.3.ECN14238



**WILBUR CURTIS CO., INC.**

6913 Acco St., Montebello, CA 90640-5403 USA

Phone: 800/421-6150 ♦ Fax: 323-837-2410

♦ Technical Support Phone: 800/995-0417 (M-F 5:30A - 4:00P PST) ♦ E-Mail: [techsupport@wilburcurtis.com](mailto:techsupport@wilburcurtis.com)

♦ Web Site: [www.wilburcurtis.com](http://www.wilburcurtis.com)

**FOR THE LATEST SPECIFICATION INFORMATION GO TO [WWW.WILBURCURTIS.COM](http://WWW.WILBURCURTIS.COM)**