

BUNN®

My Café® AP



INSTALLATION & OPERATING GUIDE

BUNN-O-MATIC CORPORATION

POST OFFICE BOX 3227

SPRINGFIELD, ILLINOIS 62708-3227

PHONE: (217) 529-6601 FAX: (217) 529-6644

To ensure you have the latest revision of the Operating Manual, or to view the Illustrated Parts Catalog, Programming Manual, or Service Manual, please visit the Bunn-O-Matic website, at www.bunn.com. This is absolutely FREE, and the quickest way to obtain the latest catalog and manual updates. For Technical Service, contact Bunn-O-Matic Corporation at 1-800-286-6070.



BUNN-O-MATIC COMMERCIAL PRODUCT WARRANTY

Bunn-O-Matic Corp. ("BUNN") warrants equipment manufactured by it as follows:

- 1) Airpots, thermal carafes, decanters, GPR servers, iced tea/coffee dispensers, MCP/MCA pod brewers thermal servers and Thermofresh servers (mechanical and digital)- 1 year parts and 1 year labor.
- 2) All other equipment - 2 years parts and 1 year labor plus added warranties as specified below:
 - a) Electronic circuit and/or control boards - parts and labor for 3 years.
 - b) Compressors on refrigeration equipment - 5 years parts and 1 year labor.
 - c) Grinding burrs on coffee grinding equipment to grind coffee to meet original factory screen sieve analysis - parts and labor for 4 years or 40,000 pounds of coffee, whichever comes first.

These warranty periods run from the date of installation BUNN warrants that the equipment manufactured by it will be commercially free of defects in material and workmanship existing at the time of manufacture and appearing within the applicable warranty period. This warranty does not apply to any equipment, component or part that was not manufactured by BUNN or that, in BUNN's judgment, has been affected by misuse, neglect, alteration, improper installation or operation, improper maintenance or repair, non periodic cleaning and descaling, equipment failures related to poor water quality, damage or casualty. In addition, the warranty does not apply to replacement of items subject to normal use including but not limited to user replaceable parts such as seals and gaskets. This warranty is conditioned on the Buyer 1) giving BUNN prompt notice of any claim to be made under this warranty by telephone at (217) 529-6601 or by writing to Post Office Box 3227, Springfield, Illinois 62708-3227; 2) if requested by BUNN, shipping the defective equipment prepaid to an authorized BUNN service location; and 3) receiving prior authorization from BUNN that the defective equipment is under warranty.

THE FOREGOING WARRANTY IS EXCLUSIVE AND IS IN LIEU OF ANY OTHER WARRANTY, WRITTEN OR ORAL, EXPRESS OR IMPLIED, INCLUDING, BUT NOT LIMITED TO, ANY IMPLIED WARRANTY OF EITHER MERCHANTABILITY OR FITNESS FOR A PARTICULAR PURPOSE. The agents, dealers or employees of BUNN are not authorized to make modifications to this warranty or to make additional warranties that are binding on BUNN. Accordingly, statements by such individuals, whether oral or written, do not constitute warranties and should not be relied upon.

If BUNN determines in its sole discretion that the equipment does not conform to the warranty, BUNN, at its exclusive option while the equipment is under warranty, shall either 1) provide at no charge replacement parts and/or labor (during the applicable parts and labor warranty periods specified above) to repair the defective components, provided that this repair is done by a BUNN Authorized Service Representative; or 2) shall replace the equipment or refund the purchase price for the equipment.

THE BUYER'S REMEDY AGAINST BUNN FOR THE BREACH OF ANY OBLIGATION ARISING OUT OF THE SALE OF THIS EQUIPMENT, WHETHER DERIVED FROM WARRANTY OR OTHERWISE, SHALL BE LIMITED, AT BUNN'S SOLE OPTION AS SPECIFIED HEREIN, TO REPAIR, REPLACEMENT OR REFUND.

In no event shall BUNN be liable for any other damage or loss, including, but not limited to, lost profits, lost sales, loss of use of equipment, claims of Buyer's customers, cost of capital, cost of down time, cost of substitute equipment, facilities or services, or any other special, incidental or consequential damages.

392, AutoPOD, AXIOM, BrewLOGIC, BrewMETER, Brew Better Not Bitter, BrewWISE, BrewWIZARD, BUNN Espresso, BUNN Family Gourmet, BUNN Gourmet, BUNN Pour-O-Matic, BUNN, BUNN with the stylized red line, BUNNlink, Bunn-OMatic, Bunn-O-Matic, BUNNserve, BUNNSERVE with the stylized wrench design, Cool Froth, DBC, Dr. Brew stylized Dr. design, Dual, Easy Pour, EasyClear, EasyGard, FlavorGard, Gourmet Ice, Gourmet Juice, High Intensity, iMIX, Infusion Series, Intellisteam, My Café, Phase Brew, PowerLogic, Quality Beverage Equipment Worldwide, Respect Earth, Respect Earth with the stylized leaf and coffee cherry design, Safety-Fresh, savemycoffee.com, Scale-Pro, Silver Series, Single, Smart Funnel, Smart Hopper, SmartWAVE, Soft Heat, SplashGard, The Mark of Quality in Beverage Equipment Worldwide, ThermoFresh, Titan, trifecta, Velocity Brew, A Partner You Can Count On, Air Brew, Air Infusion, Beverage Bar Creator, Beverage Profit Calculator, Brew better, not bitter., BUNNSource, Coffee At Its Best, Cyclonic Heating System, Daypart, Digital Brewer Control, Nothing Brews Like a BUNN, Pouring Profits, Signature Series, Tea At Its Best, The Horizontal Red Line, Ultra are either trademarks or registered trademarks of Bunn-O-Matic Corporation.

CONTENTS

Warranty	2
Introduction	3
User Notices	3
Electrical Requirements	4
Plumbing Requirements	5
Initial Setup	6
Operation	7
Cleaning	8
Tank Draining	9
Programming	10

INTRODUCTION

This equipment is factory set to brew approximately 6-8 ounces of coffee or tea into an awaiting dispenser. It is only for indoor use on a sturdy counter or shelf. Replace any unreadable or damaged labels.

USER NOTICES

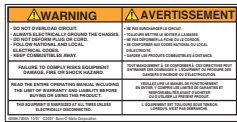

#00986.7000

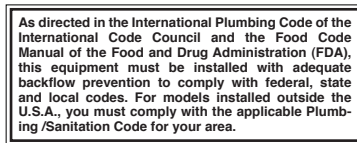

#00656.0001



#41177.0001



#00824.0002



#37881.7002

ELECTRICAL REQUIREMENTS

CAUTION - The brewer must be disconnected from the power source until specified in *Initial Set-Up*.

Refer to Data Plate on the Brewer, and local/national electrical codes to determine circuit requirements.



120 VOLT Model

Note: This electrical service consists of 2 current carrying conductors (L1 and Neutral) and a separate conductor for chassis ground.

Electrical Hook-Up

CAUTION – Improper electrical installation will damage electronic components.

1. An electrician must provide electrical service as specified.
2. Using a voltmeter, check the voltage and color coding of each conductor at the electrical source.
3. If plumbing is to be hooked up later be sure the brewer is disconnected from the power source. If plumbing has been hooked up, the brewer is ready for Initial Set-Up.

PLUMBING REQUIREMENTS

These brewers must be connected to a cold water system with operating pressure between 20 and 90 psi (138 and 620 kPa) from a ½" or larger supply line. A shut-off valve should be installed in the line before the brewer. Install a regulator in the line when pressure is greater than 90 psi (620 kPa) to reduce it to 50 psi (345 kPa). The water inlet fitting is .75-11.5 NH (HOSE THREAD). For convenience an elbow adaptor is provided to convert to a ¼" flare fitting. Bunn-O-Matic does not recommend the use of a reverse-osmosis or deionized water supply to this equipment.

NOTE - Bunn-O-Matic recommends ¼" copper tubing for installations of less than 25 feet and ⅜" for more than 25 feet from the ½" water supply line. A tight coil of tubing in the water line will facilitate moving the brewer to clean the countertop. Bunn-O-Matic does not recommend the use of a saddle valve to install the brewer. The size and shape of the hole made in the supply line by this type of device may restrict water flow.

As directed in the International Plumbing Code of the International Code Council and the Food Code Manual of the Food and Drug Administration (FDA), this equipment must be installed with adequate backflow prevention to comply with federal, state and local codes. For models installed outside the U.S.A., you must comply with the applicable Plumbing /Sanitation Code for your area.

NOTE - If a backflow preventer is required by code, a shock arrestor should be installed between backflow preventer and dispenser. Installing the shock arrestor as close to the dispenser as possible will provide the best results.

Plumbing Hook-Up

1. Flush the water line.
2. Securely attach the adaptor elbow assembly to the ¼" water supply line.
3. Securely attach adaptor elbow assembly to the the .75-11.5 NH (HOSE THREAD) fitting at the rear of the brewer.
4. Turn on the water supply.

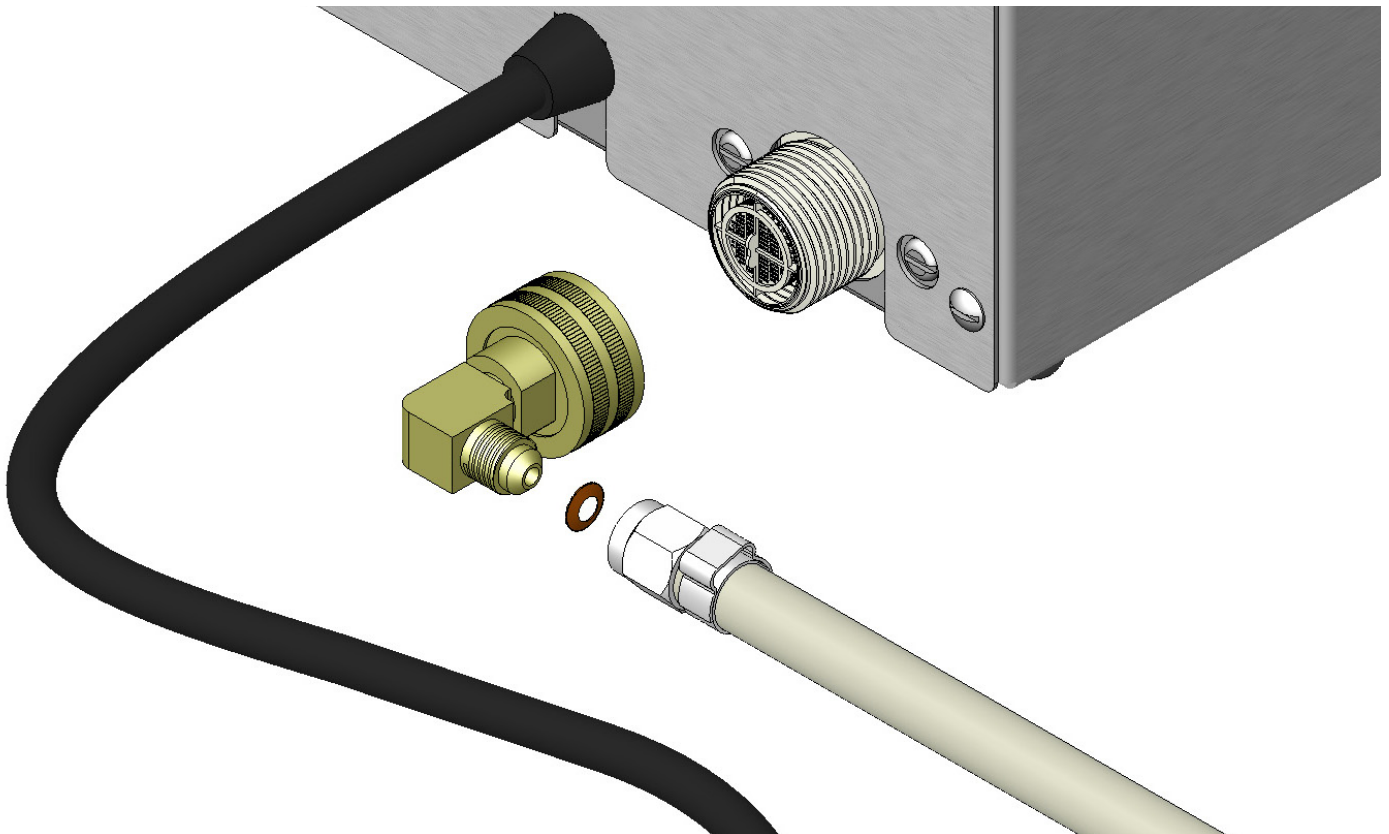

INITIAL SET-UP

1. Place a large empty cup (10 oz. or more) under the brew chamber.
2. Connect the brewer to the power source.
3. Water will flow into the tank and stop when the tank is filled to its capacity.
4. Wait approximately ten minutes for the water in the tank to heat to the proper temperature. Display will show **"HEATING"** until tank reaches it's operating temperature. Some water will drip from the brew chamber during this time; this is due to expansion and should not occur thereafter.
5. When heated, open door, then close door with switch (see illustration).
6. Press the "LARGE" Brew switch. Water will flow into the cup. When finished, discard contents of cup.
7. Water volumes and flow settings have been preset at the factory. Refer to "ADJUSTMENTS" section of this manual for the "SET BREW VOLUMES", should the volume need to be increased or decreased.
8. The brewer is now ready for use in accordance with the instructions for Coffee Brewing.

Brew water temperature is factory set at 200° F (93.3° C)
 Areas of high altitude will require lowering this temperature to prevent boiling. This chart should be used as a guide when readjusting the brew water temperature.

Altitude (Feet)	Boiling point of water		Recommended water temperature	
	° F	° C	° F	° C
-1000	213.8	101.0	200	93.3
-500	212.9	100.5	200	93.3
0	212.0	100.0	200	93.3
500	211.1	99.5	200	93.3
1000	210.2	99.0	200	93.3
1500	209.3	98.5	200	93.3
2000	208.4	98.0	200	93.3
2500	207.4	97.4	200	93.3
3000	206.5	96.9	199	92.8
3500	205.6	96.4	198	92.2
4000	204.7	95.9	197	91.7
4500	203.8	95.4	196	91.1
5000	202.9	94.9	195	90.6
5500	201.9	94.4	195	90.6
6000	201.0	93.9	194	90.0
6500	200.1	93.4	193	89.4
7000	199.2	92.9	192	88.9
7500	198.3	92.4	191	88.3
8000	197.4	91.9	190	87.8
8500	196.5	91.4	189	87.2
9000	195.5	90.8	188	86.7
9500	194.6	90.3	187	86.1
10000	193.7	89.8	186	85.6

OPERATING CONTROLS

BUNN®

PRESS ANY BUTTON TO CANCEL BREW IN PROCESS

OPEN/CLOSE
This is used to open or close the pod holder door.

LARGE BREW
Preset but can be adjusted.

HOT WATER
Push and hold for dispensing hot water only (Max 10 oz.).

SMALL BREW
Preset but can be adjusted.

OPERATION

COFFEE BREWING

1. Place cup under brew chamber FIG 8-1. (Slide booster out for small cups) FIG 8-3.
2. Press the OPEN/CLOSE switch to open pod door FIG 8-2.
3. Press fresh pod *firmly down* into pod holder FIG 8-3.
4. Press the OPEN/CLOSE switch to close pod door FIG 8-2.
5. Press the desired brew switch.
6. Once the brew cycle is finished, display will read "BREWING COMPLETE", remove cup after display returns to main screen.

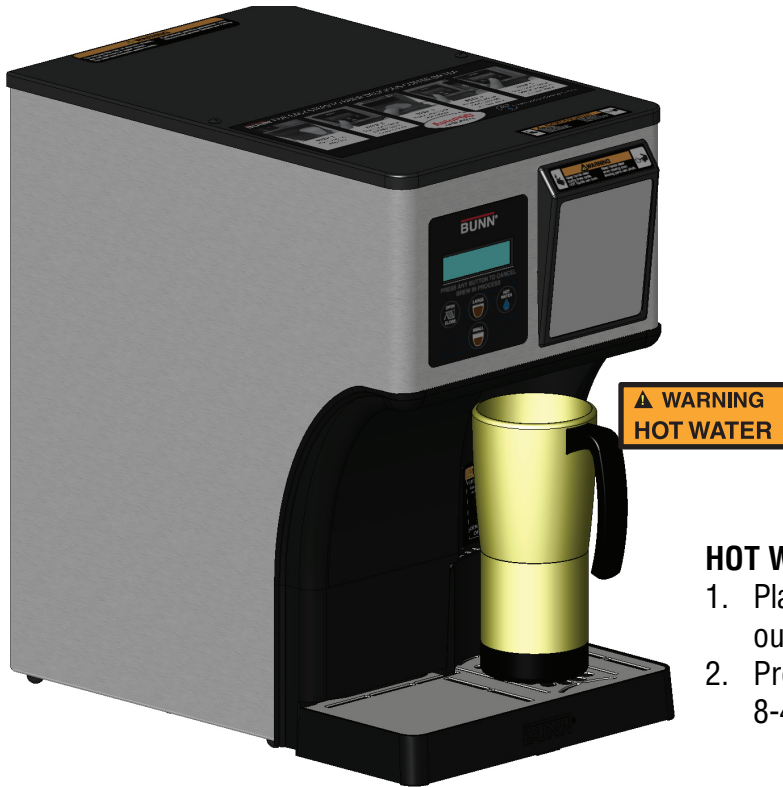

FIG 8-1

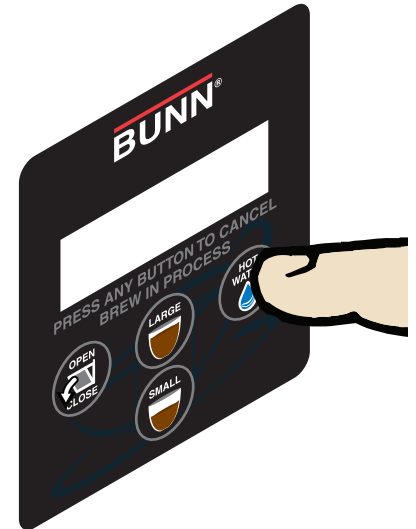

FIG 8-4

HOT WATER DISPENSING

1. Place cup under brew chamber FIG 8-1. (Slide booster out for small cups) FIG 8-3.
2. Press and hold the HOT WATER switch to fill. FIG 8-4 **NOTE:** Maximum of 10 oz.

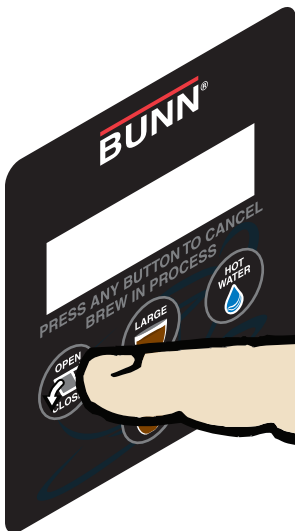

FIG 8-2

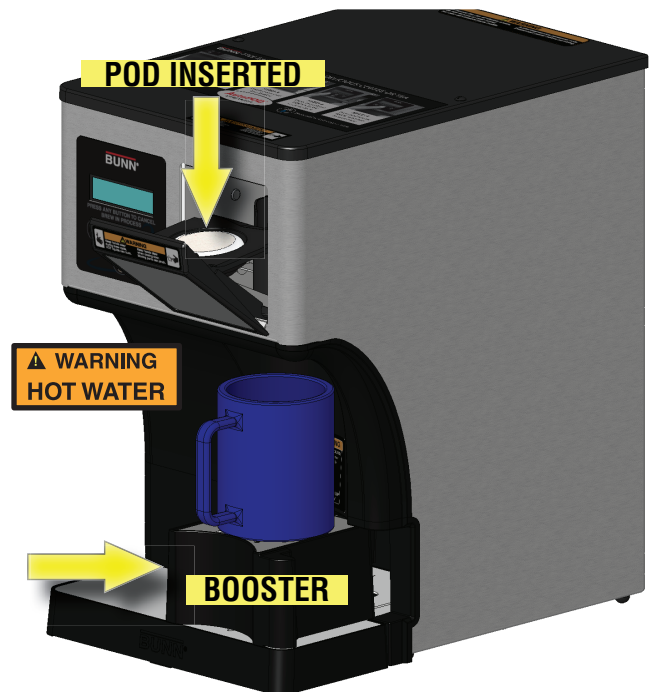

FIG 8-3

CLEANING

SPRAYHEAD

1. Open the pod door with the "OPEN/CLOSE" switch.
2. Disconnect brewer from power source and allow to cool.
3. Remove 2 screws and top cover.
3. Slip one hand through pod door opening. With other hand turn thumbscrew counterclockwise. Remove sprayhead assembly through front. Fig 8-1
4. Remove seal from sprayhead.
5. Check and clean the sprayhead. The sprayhead holes must always remain open. Fig 8-2. Clean all the holes in the plastic sprayhead to remove any mineral deposits. Wash and rinse in sink.
6. When reassembling sprayhead, be sure to have seal installed with ridge facing up (A). Fig 8-3



FIG 8-1

The use of a damp cloth rinsed in any mild, nonabrasive, liquid detergent is recommended for cleaning all surfaces on Bunn-O-Matic equipment.

BIN /DRIPTRAY

1. Pull the drip tray assembly straight towards you.
2. Pull the bin straight out and empty as required.
3. Separate the parts as shown in Fig 8-4 and wash with mild, nonabrasive, liquid detergent.
4. Assembly is in reverse order.

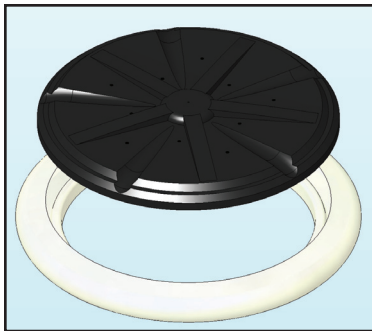

FIG 8-2
SHOWN UPSIDEDOWN
FOR CLARITY

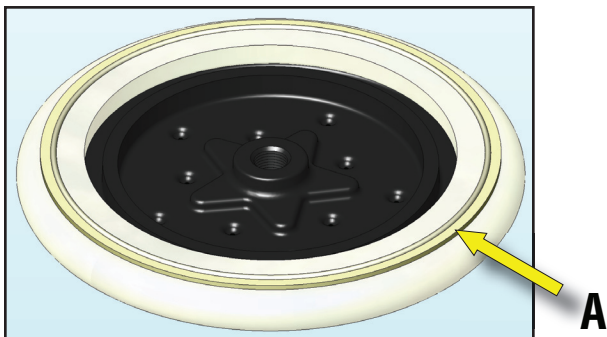

FIG 8-3

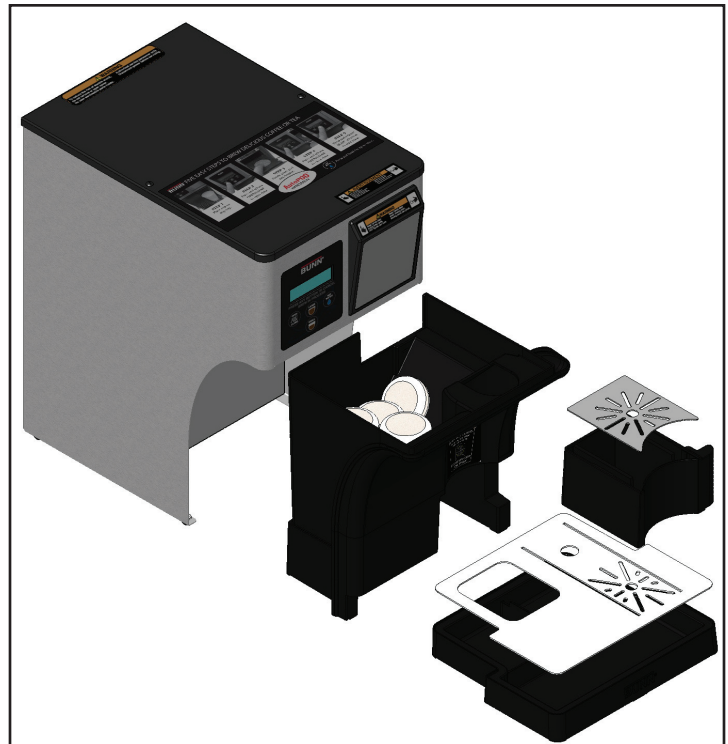

FIG 8-4

TANK DRAINING

TANK DRAINING - My Café AP

1. Disconnect the power and water supply to brewer. Allow brewer to cool before proceeding.
2. Remove the top and rear covers. Place brewer next to a sink.
3. Direct the drain hose into sink. Remove clamp and plug. FIG. 9-1
4. Allow water to syphon out of tank. NOTE: A small amount of water will remain below the tube level. If necessary, insert a syphon hose through one of the grommet holes to remove remaining water.
5. Replace the plug and clamp.
6. Replace the covers and tighten screws.



FIG 9-1

PROGRAMMING SWITCHES

HIDDEN SWITCH
Press until display reads
"BREW LOCKOUT"

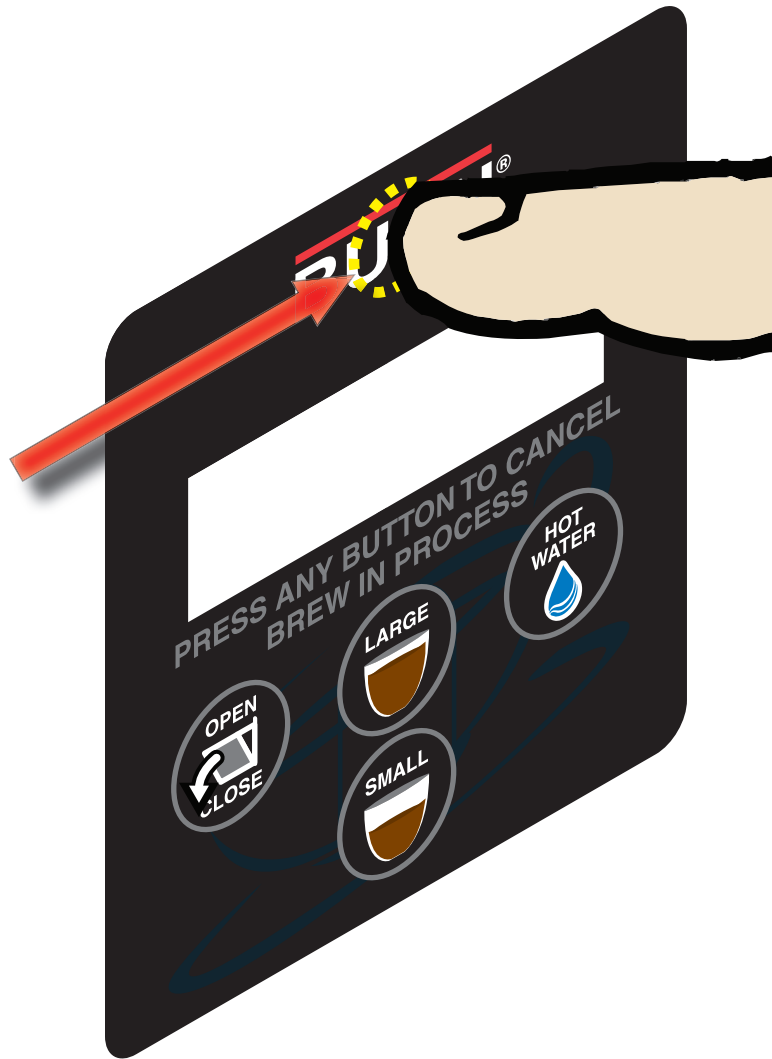

HIDDEN SWITCH
Step forward through
screens

OPEN/CLOSE
"NO" or (-)

LARGE BREW (A)
"DONE"



HOT WATER
"YES" or (+)

SMALL BREW (B)
Step backwards through
screens

PROGRAM OVERVIEW

BREW LOCKOUT (YES/NO)

Setting to "YES" will only allow brews at or above the "SET READY" temp screen.

BREW OZ. (A/B) (1-16)

Adjust brew volume.

BREW METER (A/B) (1-5)

Simplified pulse brew adjustment.

1=Preinfusion. 2-5=pulse brew, 2 being the shortest pulse brew cycle, 5 the longest pulse brew cycle.

ENTER SERVICE #

Program service phone number to be displayed anytime there is a fault message.

ENTER PASSWORD

User must enter a 3 digit number to access remainder of adjustments. If no number has been pre programmed (0 0 0), then access is allowed.

SET PASSWORD (001-999)

Program any three digit number as a password.

SET LANGUAGE

Choose between English or Spanish.

UNITS

Choose between English or metric.

SET TEMP

Adjust tank temperature 185 to 205° F (85 to 96° C)

SET READY

Sets the minimum temperature allowable to start a brew cycle. Range: (2° to 20° F) or (2° to 10° C) below the set temperature.

HOT H2o LOCKOUT

Setting to "YES" will only allow dispensing of hot water at or above the "H2o READY" temp screen.

HOT H2o READY

Sets the minimum temperature allowable to start dispensing hot water.

ENTER ASSET #

This function allows the you to enter in an optional asset number. This can be useful for tracking the usage or service of an individual machine within a group.

SET PULSE BREW (A/B)

Individually adjust on/off times.

AIR TIME (A/B) (1-25)

Time the brew tank is purged at the end of each brew cycle.

BREWS TO EMPTY (OFF/15-25)

Set number of used pods in bin to turn on "EMPTY BIN" message.

ENABLE ENERGY SAVER

Choose to have the tank heaters turn off, or reduce the tank temp to (140° F) or (60° C) once the "SET IDLE TIME" has expired. .5-50.0 hrs.

BREW COUNTS

Retains the total number of brew cycles completed. There is one reset-able counter, and one life counter that is not reset-able.

CALIBRATE FLOW

Measure and enter the actual flow rate coming out of the sprayhead.

SERVICE TOOLS

Diagnostic tool for troubleshooting purposes only

FACTORY DEFAULTS

Reset all brew settings, calibrations back to factory pre-sets. Requires following "INITIAL SETUP" procedure.

Refer to the "PROGRAMMING MANUAL" at www.bunn.com for more advanced programming information.

ADJUSTMENTS & OPTIONAL SETTINGS - My Café AP

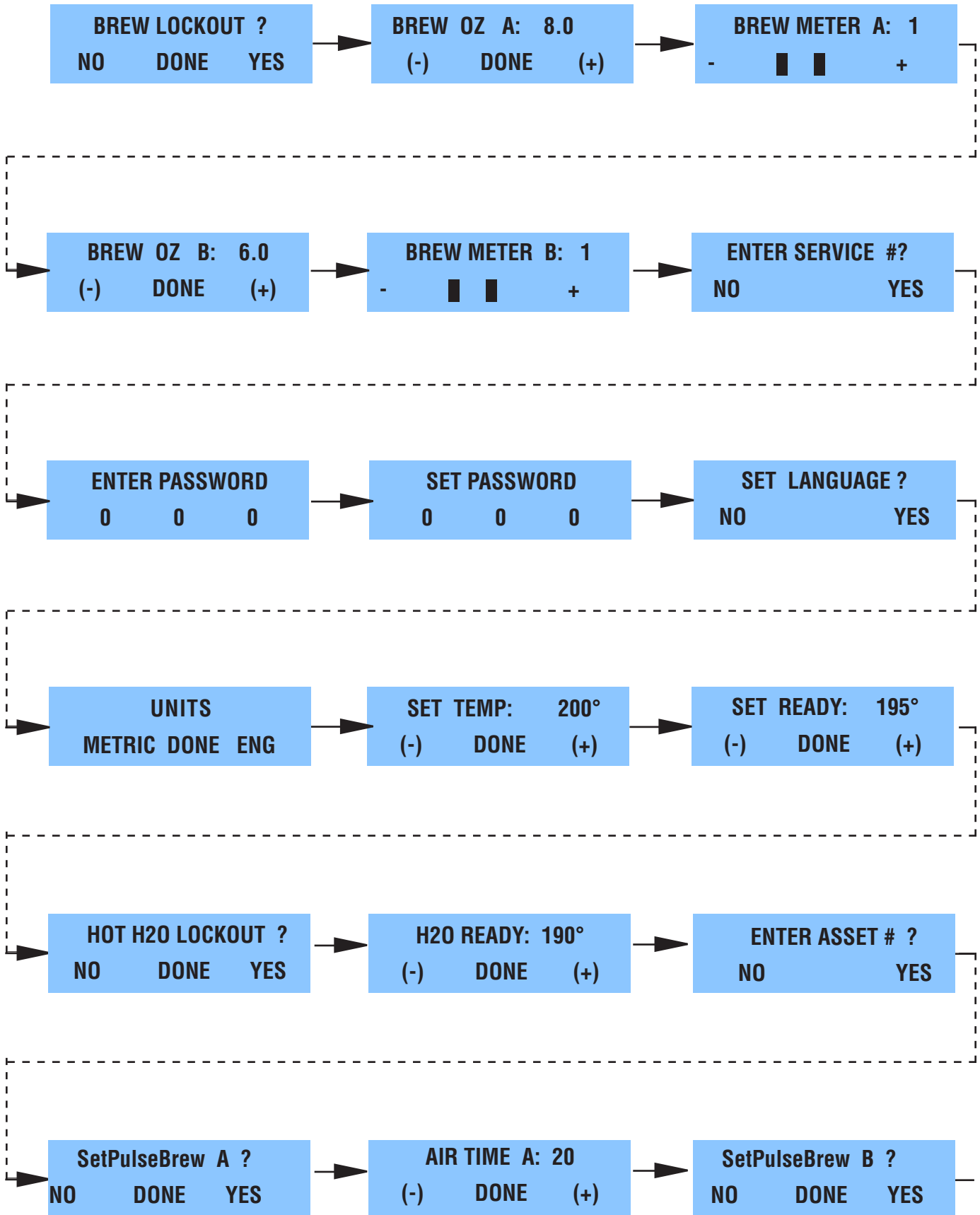

ADJUSTMENTS & OPTIONAL SETTINGS - My Café AP (CONT.)

